

vex[®]
ROBOTICS
COMPETITION
OVER UNDER

2023 - 2024
Game Manual
Version 0.1

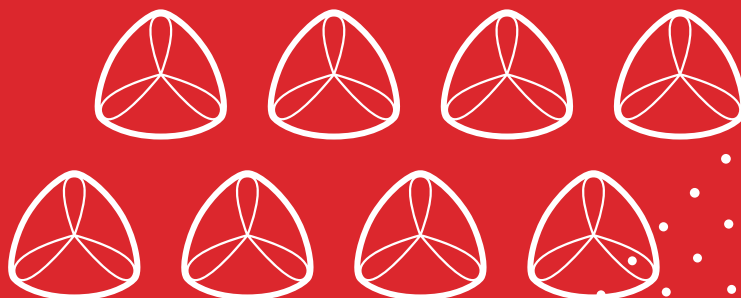

Table of Contents

Section 1

Introduction	1
--------------------	---

Section 2

The Game	6
General Definitions.....	8
Game-Specific Definitions	13
Scoring.....	21
Safety Rules	25
General Game Rules	25
Specific Game Rules.....	33

Section 3

The Robot	40
Inspection Rules.....	40

Section 4

The Tournament	54
Tournament Rules.....	57
Tournament Definitions.....	54

Appendix A - Field Overview

Game Field Introduction.....	A1
Field Overview.....	A2
Game Objects & Field Bill of Materials	A3
Field Specifications Introduction.....	A4

Appendix B - Robot Skills

Robot Skills Challenge Description.....	B1
Robot Skills Challenge Definitions	B2
Robot Skills Challenge Rules	B3
Robot Skills Challenge Scoring	B4
Skills Stop Time	B5
Robot Skills Challenge Ranking at Events.....	B6
Robot Skills Challenge Ranking Globally	B7
League Events	B7

Changelog

Version 0.1 - April 29, 2023

- Initial Release

Quick Reference Guide

Scoring Rules (Pages 21-24)

<SC1>	All scoring statuses are evaluated immediately after the <i>Match</i> ends
<SC2>	Scoring of the <i>Autonomous Bonus</i> is immediately after the <i>Autonomous Period</i>
<SC3>	Scored in a <i>Goal</i> criteria
<SC4>	Scored in an <i>Offensive Zone</i> criteria
<SC5>	<i>Alliance Triballs</i>
<SC6>	<i>Elevation Tier</i> points
<SC7>	<i>Autonomous Win Point</i>

Safety Rules (Page 25)

<S1>	Be safe out there
<S2>	<i>Students</i> must be accompanied by an <i>Adult</i> .
<S3>	Stay inside the <i>Field</i>
<S4>	Wear safety glasses

General Game Rules (Pages 25-32)

<G1>	Treat everyone with respect
<G2>	VRC is a <i>Student</i> -centered program
<G3>	Use common sense
<G4>	The <i>Robot</i> must represent the skill level of the <i>Team</i>
<G5>	<i>Robots</i> begin the <i>Match</i> in the starting volume
<G6>	Keep your <i>Robots</i> together
<G7>	Don't clamp your <i>Robot</i> to the <i>Field</i>
<G8>	Only <i>Drive Team Members</i> , and only in the <i>Alliance Station</i>
<G9>	Hands out of the <i>Field</i>
<G10>	Controllers must stay connected to the <i>Field</i>
<G11>	<i>Autonomous</i> means "no humans"
<G12>	All rules still apply in the <i>Autonomous Period</i>
<G13>	Don't destroy other <i>Robots</i> . But, be prepared to encounter defense
<G14>	<i>Offensive Robots</i> get the "benefit of the doubt"
<G15>	You can't force an opponent into a penalty
<G16>	No <i>Holding</i> for more than 5 seconds
<G17>	Use <i>Triballs</i> to play the game

Specific Game Rules (Pages 33-39)

<SG1>	Starting a <i>Match</i>
<SG2>	Horizontal expansion is limited
<SG3>	Keep <i>Triballs</i> in the <i>Field</i>

<SG4>	Each <i>Robot</i> gets one <i>Alliance Triball</i> as a <i>Preload</i>
<SG5>	Stay away from nets on the <i>Goals</i>
<SG6>	Match Load <i>Triballs</i> may be safely introduced during the <i>Match</i> under certain conditions
<SG7>	<i>Possession</i> is limited to one (1) <i>Triball</i>
<SG8>	Stay out of your opponent's <i>Goal</i> unless they are <i>Double-Zoned</i>
<SG9>	Stay in your starting zone during the <i>Autonomous Period</i>
<SG10>	Enter the <i>Neutral Zone</i> during the <i>Autonomous Period</i> at your own risk
<SG11>	<i>Elevated Robots</i> are protected

Robot Rules (Pages 40-53)

<R1>	One <i>Robot</i> per <i>Team</i>
<R2>	<i>Robots</i> must represent the <i>Team's</i> skill level
<R3>	<i>Robots</i> must pass inspection
<R4>	<i>Robots</i> must fit within an 18" x 18" x 18" volume
<R5>	<i>Robots</i> must be safe
<R6>	<i>Robots</i> are built from the VEX V5 system
<R7>	Certain non-VEX components are allowed
<R8>	Decorations are allowed
<R9>	Officially registered <i>Team</i> numbers must be displayed on <i>Robot License Plates</i>
<R10>	Let go of <i>Triballs</i> after the <i>Match</i>
<R11>	<i>Robots</i> have one microcontroller
<R12>	Motors are limited
<R13>	Electrical power comes from VEX batteries only
<R14>	No modifications to electronic components are allowed
<R15>	Most modifications to non-electrical components are allowed
<R16>	<i>Robots</i> use VEXnet
<R17>	Give the radio some space
<R18>	A limited amount of custom plastic is allowed
<R19>	A limited amount of tape is allowed
<R20>	Certain non-VEX fasteners are allowed
<R21>	New VEX parts are legal
<R22>	Pneumatics are limited
<R23>	One or two Controllers per <i>Robot</i>
<R24>	Custom V5 Smart Cables are allowed
<R25>	Keep the power button accessible
<R26>	Use a "Competition Template" for programming
<R27>	There is a difference between accidentally and willfully violating a <i>Robot</i> rule

Tournament Rules (Pages 57-67)

<T1>	<i>Head Referees</i> have final authority on all gameplay ruling decisions
<T2>	<i>Head Referees</i> must be qualified

<T3>	The Drive Team is permitted to immediately appeal a <i>Head Referee's</i> ruling
<T4>	<i>Event Partners</i> have final authority regarding all non-gameplay decisions
<T5>	A <i>Team's Robot</i> and/or <i>Drive Team Member</i> should attend every <i>Match</i>
<T6>	<i>Robots</i> at the field must be ready to play
<T7>	<i>Match replays</i> are allowed, but rare
<T8>	<i>Disqualifications</i>
<T9>	Each elimination <i>Alliance</i> gets one <i>Time Out</i>
<T10>	Be prepared for minor <i>Field</i> variance
<T11>	Fields may be repaired at the <i>Event Partner's</i> discretion
<T12>	The red <i>Alliance</i> places last
<T13>	<i>Qualification Matches</i> follow the <i>Match Schedule</i>
<T14>	Each <i>Team</i> will have at least six <i>Qualification Matches</i>
<T15>	<i>Qualification Matches</i> contribute to a <i>Team's</i> ranking for <i>Alliance Selection</i>
<T16>	<i>Qualification Match</i> tiebreakers
<T17>	Send a <i>Student</i> representative to <i>Alliance Selection</i>
<T18>	Each <i>Team</i> may only be invited once to join an <i>Alliance</i>
<T19>	<i>Elimination Matches</i> follow the <i>Elimination Bracket</i>
<T20>	<i>Elimination Matches</i> are a blend of "Best of 1" and "Best of 3"
<T21>	The number of <i>Alliances</i> is determined by the size of the tournament
<T22>	Fields at an event must be consistent with each other
<T23>	There are three types of field control that may be used
<T24>	There are two types of field perimeter that may be used

Robot Skills Challenge Rules (Pages B3-B4)

<RSC1>	All rules from "The Game" section of the manual apply to the Robot Skills Challenge
<RSC2>	<i>Robots</i> may start the <i>Robot Skills Match</i> in any legal starting location
<RSC3>	<i>Teams</i> may utilize the forty-four (44) <i>Match Load Triballs</i>
<RSC4>	<i>Teams</i> play as if they are on the red <i>Alliance</i>
<RSC5>	Elevation points are awarded based on the <i>Elevation Tier</i>
<RSC6>	Skills Challenge fields do not require the same modifications as the Head-to-Head Fields
<RSC7>	<i>Triballs</i> which come to rest on top of the red <i>Goal</i> may not be retrieved

Section 1

Introduction

Overview

This section provides an introduction to the VEX Robotics Competition (VRC) and VRC Over Under.

The VEX Robotics Competition

Our world faces a serious problem. It's a problem that, without explicit and intentional action, will eventually stagnate global progress and lead to a workforce that is unmotivated and ill-equipped to solve its future problems. As the world grows more technologically complex, the challenges we face every day will continue to escalate along with it. A cell phone has more failure modes than a landline. The internals of an electric vehicle are more difficult to comprehend than a V8 combustion engine. Unmanned drone legislation is more nuanced than defining a maximum speed limit.

Dubbed "the STEM problem," the situation is equally simple to understand, yet difficult to solve. In many cases, the traditional methods of teaching science, technology, engineering, and math (STEM) will not be enough to adequately prepare students for this complex world. This is often coupled with the unfortunate reality that by the time they reach an age capable of grasping these critical topics, students may have already determined that they are "not cool" or "boring." Without the skills or passion necessary to approach these problems in an educated manner, you cannot possibly expect to be productive in making forward progress or even sustaining the status quo.

The VEX Robotics Competition exists to solve this problem. Through its uniquely engaging combination of teamwork, problem solving, and scientific discovery, the study of competitive robotics encompasses aspects of STEM. You're not building VEX robots because your future job will involve tightening shaft collars on a metal bar—you're executing an engineering design and problem-solving process that resembles the same mindset used by rocket scientists, brain surgeons, and inventors around the world. VEX Robotics Competition Over Under is not just a game that we invented because it is fun to play—it is a vehicle for teaching (and testing) teamwork and perseverance in the face of hardship, and provides a methodology to approach and solve new challenges with confidence.

Contained in this manual are the rules that shape VRC Over Under. These rules are designed to simulate the constraints that will outline any real-world project. They are intended to promote creativity without punishing innovation. They are balanced to promote fair play while encouraging competition.

We encourage you to keep in mind that a VEX Robotics Competition game is more than just a set of game objectives worth varying amounts of points. It is an opportunity to hone the lifelong skills that will characterize the problem-solving leaders of tomorrow.

Good luck, and we'll see you on the playing field!

Sincerely,

The VEX Robotics Game Design Committee, composed of members from the Robotics Education & Competition Foundation, DWAB Technology, and VEX Robotics

VEX Robotics Competition Over Under: A Primer

VEX Robotics Competition Over Under is played on a 12'x12' square field, set up as illustrated in the figures throughout.

In Head-to-Head Matches, two (2) *Alliances*—one (1) "red" and one (1) "blue"—composed of two (2) *Teams* each, compete in *Matches* consisting of a fifteen (15) second *Autonomous Period* followed by a one minute and forty-five second (1:45) *Driver Controlled Period*.

The object of the game is to attain a higher score than the opposing *Alliance* by Scoring *Triballs* in *Goals* and by Elevating at the end of the *Match*.

An *Autonomous Win Point* is awarded to any *Alliance* that completes three (3) assigned tasks by the end of the *Autonomous Period*.

An *Autonomous Bonus* is awarded to the *Alliance* that has the most points at the end of the *Autonomous Period*.

Teams may also compete in *Robot Skills Matches*, where one (1) *Robot* tries to score as many points as possible. See Appendix B for more information.

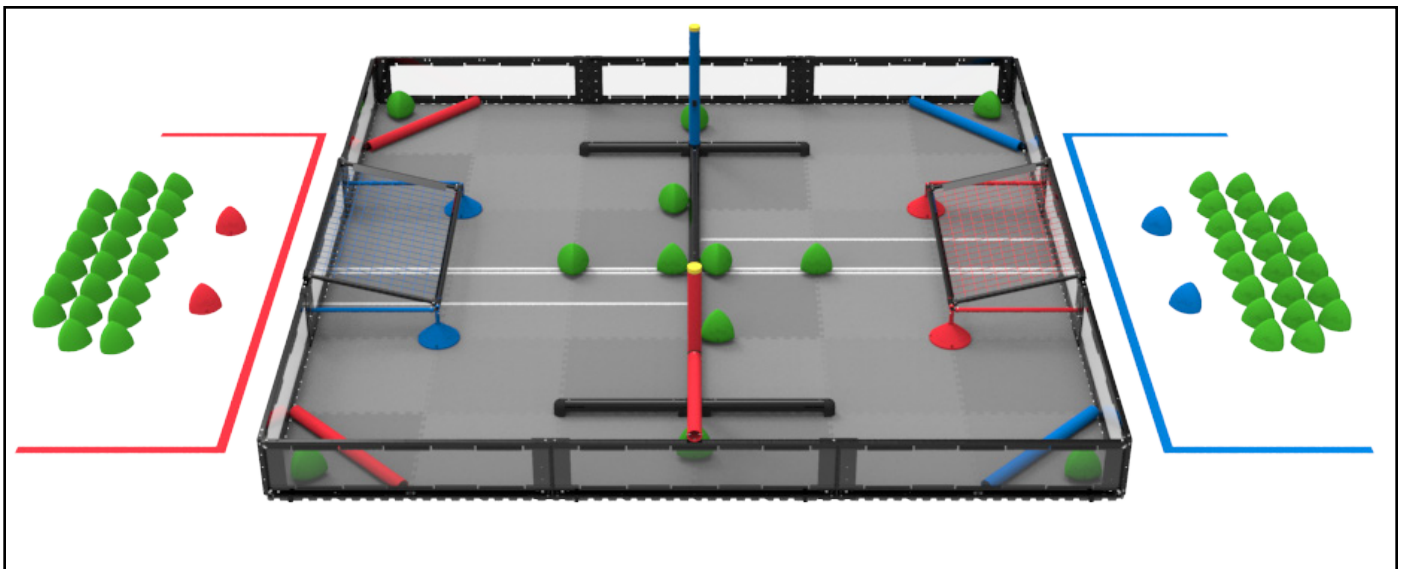

About the Game Manual - A Note from the GDC

This Game Manual and its appendices contain everything there is to know about this season's game, VRC Over Under. It is intended to be a resource for all *Teams*, *Head Referees*, *Event Partners*, and other members of the VRC community.

The rules contained in the following pages can be thought of as "constraints" that define this game, just as engineers begin any design project by defining their constraints. At the beginning of a season, "constraints" are all we have. We don't know what the winning *Robot*, best strategy, or most-frequently-violated rule will be any more than you do. Isn't that exciting?

When exploring a new game, please approach this Game Manual with that mentality of looking at rules as "constraints." The Game Manual and its appendices contain the full and complete list of constraints that are available for a competitor to strategize, design, and build their *Robots*.

Obviously, all *Teams* must adhere to these rules, and any stated intents of these rules. However, beyond that, there is no "right" way to play. There are no hidden restrictions, assumptions, or intended interpretations beyond what is written here. So, it is up to you, the competitor, to find the path through these constraints that best suits your team's goals and ambitions.

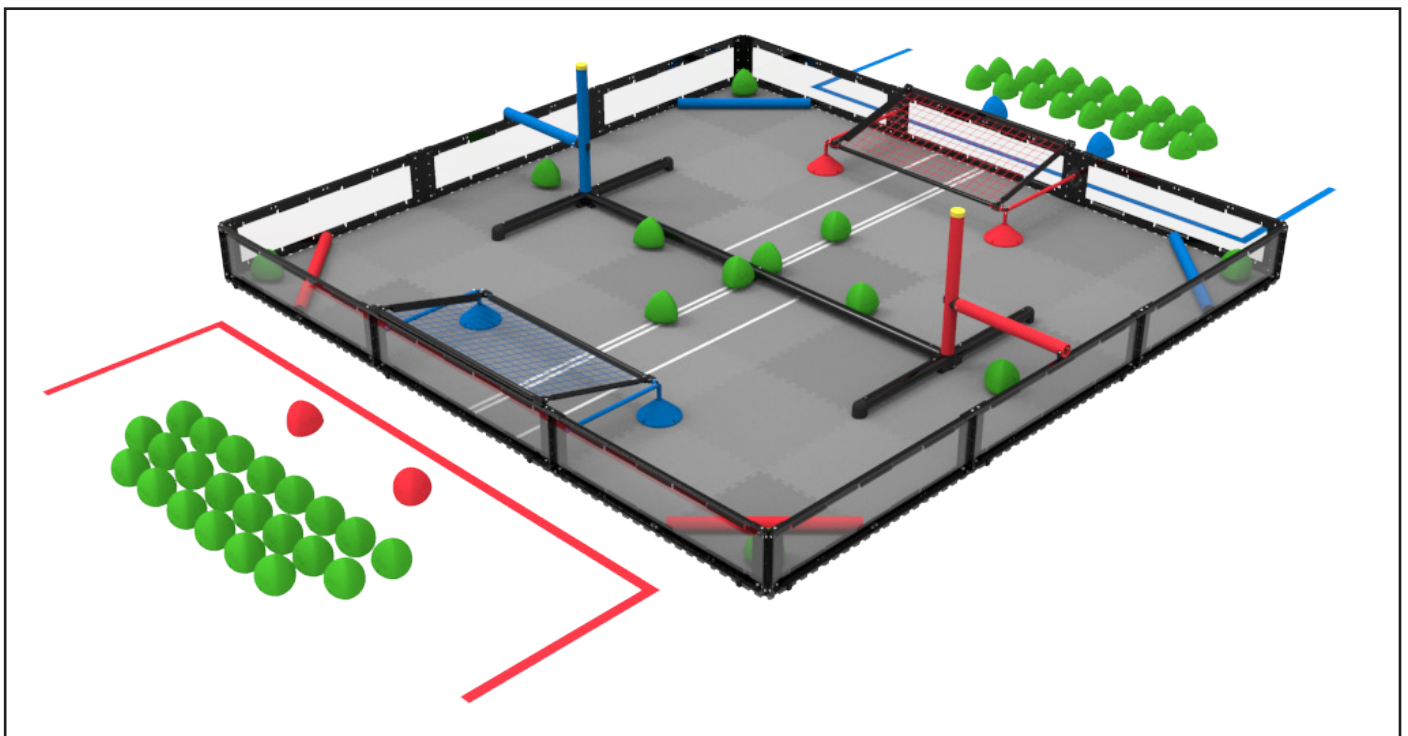

Updates

This manual will have a series of “major” and “minor” updates over the course of the season. Each version is official and must be used in official VRC events until the release of the next version, upon which the previous version becomes void.

Known major release dates are as follows:

April 29, 2023	Version 0.1	Initial game release
May 16, 2023	N/A	Official Q&A system opens
June 13, 2023	Version 0.2	VEX U Appendix release, and minor typographical errors or formatting issues found in the initial release. There will be very few rule changes, if any.
June 27, 2023	Version 1.0	May include critical gameplay or rule changes inspired by input from the official Q&A system and the VEX community.
August 1, 2023	Version 2.0	May include gameplay or rule changes inspired by early-season events.
October 3, 2023	Version 2.1	Clarification update only
December 5, 2023	Version 2.2	Clarification update only
January 30, 2024	Version 3.0	May include gameplay or rule changes inspired by mid-season events.
April 2, 2024	Version 4.0	May include critical gameplay or rule clarifications pertaining specifically to the VEX Robotics World Championship

In addition to these known major updates, there may also be unscheduled updates released throughout the season if deemed critical by the GDC. **Any unscheduled updates will always be released on a Tuesday, no later than 5:00 PM CST (11:00 PM GMT).** These updates will be announced via the VEX Forum, automatically pushed to the VRC Hub app, and shared via VEX Robotics / REC Foundation social media & email marketing channels.

Game Manual updates are effective immediately upon release; it is every *Team’s* responsibility to be familiar with all rules and updates. There are no “grace periods” if an update prohibits a previously legal part, mechanism, or strategy.

Note: REC Foundation Event Support Managers will contact Event Partners involved with multi-week league events that “cross over” an unscheduled update. If a rule change impacts their event (such as a Robot which previously passed inspection no longer being legal), these cases will be reviewed individually depending on the context of the event and the rule that has changed. This is the only possible “grace period” exception.

The Q&A System

When first reviewing a new robotics game, it is natural to have questions about situations which may not be immediately clear. Navigating the Game Manual and seeking out answers to these questions is an important part of learning a new game. In many cases, the answer may just be in a different place than you first thought—or, if there is no rule explicitly prohibiting something, then that usually means it is legal!

However, if a *Team* is still unable to find an answer to their question after closely reviewing the relevant rules, then every *Team* has the opportunity to ask for official rules interpretations in the VEX Robotics Question & Answer System. These questions may be posted by a *Team's Adult* representative via the RobotEvents account that is associated with that *Team*.

All responses in this Q&A system should be treated as official rulings from the VEX Robotics *Game Design Committee*, and they represent the correct and official interpretation of the VEX Robotics Competition Rules. The Q&A system is the only source besides the Game Manual for official rulings and clarifications.

The VEX Robotics Competition Question & Answer System can be found at <https://www.robotevents.com/VRC/2023-2024/QA>.

Before posting on the Q&A system, be sure to review the Q&A Usage Guidelines, which can be found at <https://www.robotevents.com/VRC/2023-2024/QA/guidelines>.

1. Read and search the manual before posting.
2. Read and search existing Q&As before posting.
3. Quote the applicable rule from the latest version of the manual in your question.
4. Make a separate post for each question.
5. Use specific and appropriate question titles.
6. Questions will (mostly) be answered in the order they were received.
7. This system is the only source for official rules clarifications.

If there are any conflicts between the Game Manual and other supplemental materials (e.g., Referee Certification courses, the VRC Hub app, etc.), the most current version of the Game Manual takes precedence.

Similarly, it can never be assumed that definitions, rules, or other materials from previous seasons apply to the current game. Q&A responses from previous seasons are not considered official rulings for the current game. Any relevant clarifications that are needed should always be re-asked in the current season's Q&A.

Section 2

The Game

Field Overview

The VEX Robotics Competition Over Under field consists of the following:

- Sixty (60) *Triballs*
 - Four (4) *Alliance Triballs*, two (2) per *Alliance*, that can be used as *Preloads*
 - Forty-four (44) that are used as Match Loads, twenty-two (22) per *Alliance*
 - Twelve (12) that begin on the field
- Two (2) sets of *Elevation Bars*, one (1) per *Alliance*
- Two (2) *Goals*, one (1) per *Alliance*
- Four (4) *Match Load Bars / Match Load Zones*, two (2) per *Alliance*

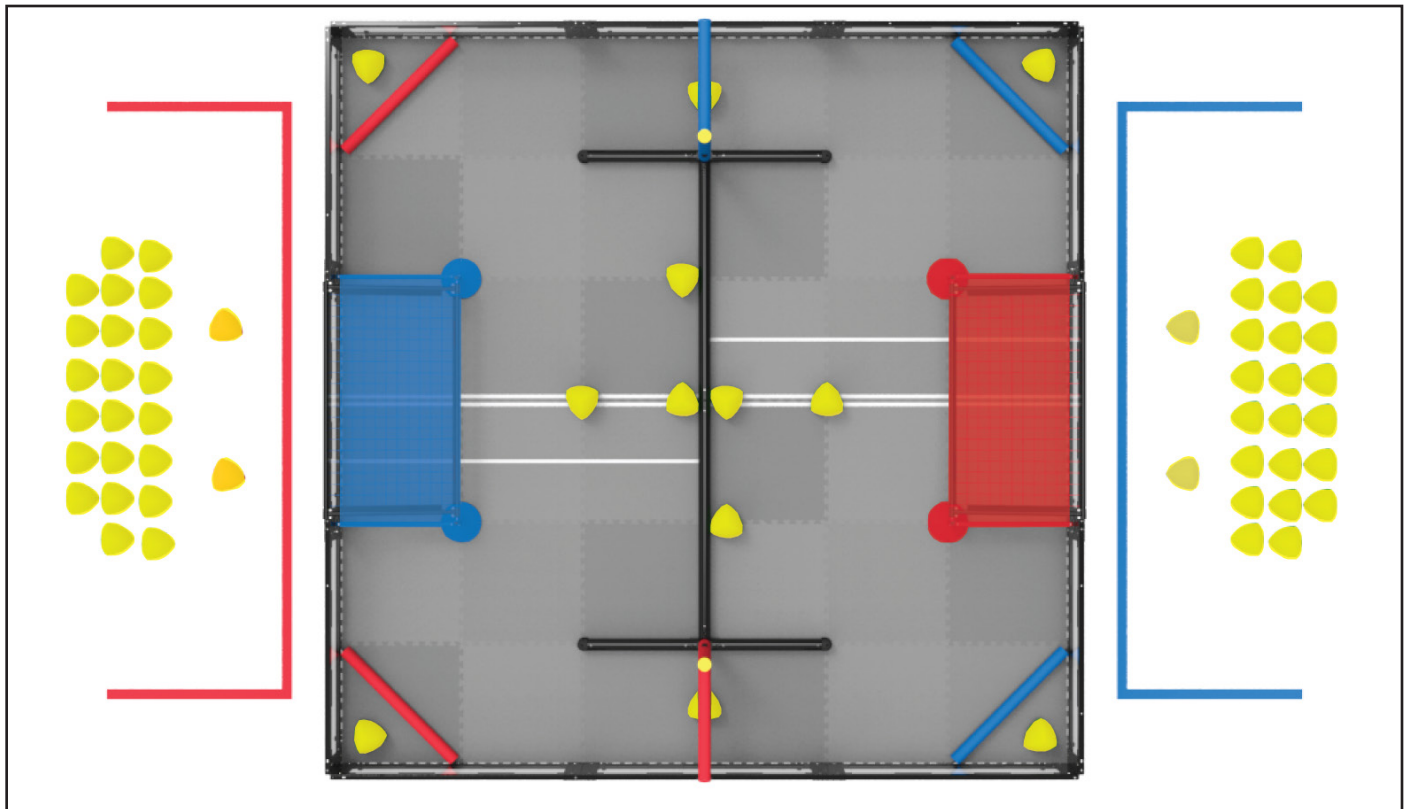

Figure 1: Top view of the field in its starting configuration, with highlighted Triballs (yellow), Red Alliance Goal (red), and Blue Alliance Goal (blue).

Note: The illustrations in this section of the Game Manual are intended to provide a general visual understanding of the game. Teams should refer to official field specifications, found in Appendix A, for exact field dimensions, a full field bill of materials, and exact details of field construction.

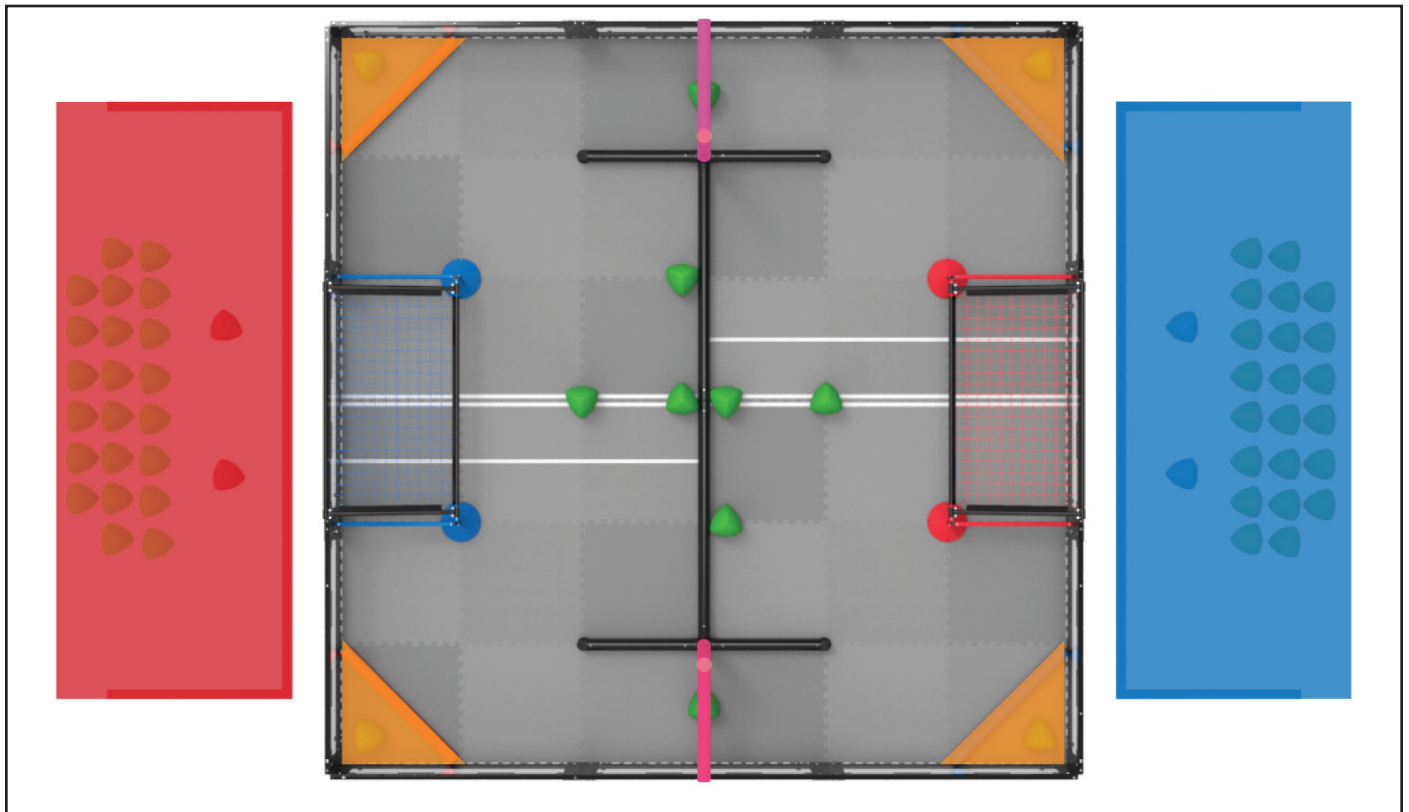

Figure 2: Top view of the field with highlighted Elevation Bars (pink), Match Load Zones (orange), Red Alliance Station (red) and Blue Alliance Station (blue).

General Definitions

Adult – Anyone who is not a *Student* or another defined term (e.g., *Head Referee*).

Alliance – A pre-assigned grouping of two (2) *Teams* that are paired together during a given *Match*.

Alliance Station – The designated regions where the *Drive Team Members* must remain for the duration of the *Match*.

Autonomous Bonus – A point bonus awarded to the *Alliance* that has earned the most points at the end of the *Autonomous Period*. See <SC2> for more information.

Autonomous Win Point - An additional *Win Point* awarded to any *Alliance* that has completed a defined set of tasks at the end of the *Autonomous Period* of a *Qualification Match*. See <SC7> for more information.

Disablement – A penalty applied to a *Team* for a rule *Violation*. A *Team* that is Disabled is not allowed to operate their *Robot* for the remainder of the *Match*, and the *Drive Team Member(s)* will be asked to place their controller(s) on the ground.

Disqualification – A penalty applied to a *Team* for a rule *Violation*. A *Team* that receives a *Disqualification* in a *Qualification Match* receives zero (0) *Win Points*, (0) *Autonomous Win Points*, (0) *Autonomous Points*, and (0) *Strength of Schedule Points*. When a *Team* is Disqualified in an *Elimination Match*, the entire *Alliance* is Disqualified and they receive a loss for the *Match*. At a *Head Referee's* discretion, repeated *Violations* and/or *Disqualifications* for a single *Team* may lead to its *Disqualification* for the entire tournament (see <T8>). A *Team* that receives a *Disqualification* in a *Driving Skills Match* or *Autonomous Coding Skills Match* receives a score of zero (0) for that *Robot Skills Match*.

Drive Team Member(s) – A *Student* who stands in the *Alliance Station* during a *Match*. Adults are not allowed to be *Drive Team Members*. See rules <G8>, <G9>, and <G10>.

Entanglement – A *Robot* status. A *Robot* is Entangled if it has grabbed, hooked, or attached to an opposing *Robot* or a *Field Element*. See rules <G13> and <SG5>.

Field Element – The foam field tiles, field perimeter, white tape, *Elevation Bars*, *Match Load Bars*, *Goals*, and all supporting structures or accessories (such as *Alliance Station* posts, field monitors, etc.).

Game Design Committee (GDC) - The creators of VRC Over Under, and authors of this Game Manual.

Holding - A *Robot* status. A *Robot* is considered to be *Holding* if it meets any of the following criteria during a *Match*:

- **Trapping** - Limiting the movement of an opponent *Robot* to a small or confined area of the field, approximately the size of one foam field tile or less, without an avenue for escape. Note that if a *Robot* is not attempting to escape, it is not considered Trapped.
- **Pinning** - Preventing the movement of an opponent *Robot* through contact with the Field Perimeter, a Field or Game Element, or another *Robot*.
- **Lifting** - Controlling an opponent's movements by raising or tilting the opponent's *Robot* off of the foam tiles.

Match – A set time period, consisting of *Autonomous* and/or *Driver Controlled Periods*, during which *Teams* play a defined version of Over Under to earn points. See Section 4.

- **Autonomous Period** – A time period during which *Robots* operate and react only to sensor inputs and commands pre-programmed by the *Students* into the *Robot* control system.
- **Driver Controlled Period** – A time period during which *Drive Team Members* operate their *Robot* via remote control.

Match Type	Participants	Pertinent Rules	Autonomous Period (m:ss)	Driver Controlled Period (m:ss)
Head-to-Head	Two <i>Alliances</i> (red/blue), each composed of two <i>Teams</i> , with one <i>Robot</i> each	Scoring ("SC"), Game ("G") and Specific Game ("SG") sections	0:15	1:45
Driver Skills Match	One <i>Team</i> , with one <i>Robot</i>	Appendix B	None	1:00
Autonomous Coding Skills Match	One <i>Team</i> , with one <i>Robot</i>	Appendix B	1:00	None
VEX AI Competition	Two <i>Teams</i> , (red/blue), with two <i>Robots</i> each, utilizing the VEX GPS and VEX AI Camera	Appendix D	0:15	1:45

Note: The time periods in VAIC are referred to as the Isolation Period and the Interaction Period. The VEX AI Challenge Appendix will be released in an upcoming Game Manual Update.

Robot – A machine that has passed inspection, designed to execute one or more tasks autonomously and/or by remote control from a *Drive Team Member*.

Student – A person is considered a *Student* if they meet both of the following criteria:

1. Anyone who is earning or has earned credit toward a high school diploma, certificate, or other equivalent during the six (6) months preceding the VEX Robotics World Championship. Courses earning credits leading up to high school would satisfy this requirement.
2. Anyone born after May 1, 2004 (i.e., who will be 19 or younger at VEX Worlds 2024). Eligibility may also be granted based on a disability that has delayed education by at least one year.
 - **Middle School Student** – A *Student* born after May 1, 2008 (i.e., who will be 15 or younger at VEX Worlds 2024). A *Middle School Student* may “play up” and compete as a *High School Student*.
 - **High School Student** – Any eligible *Student* that is not a *Middle School Student*.

Team – One or more *Students* make up a *Team*.

- A *Team* is classified as a *Middle School Team* if all members are *Middle School Students*.
- A *Team* is classified as a *High School Team* if any of its members are *High School Students*, or if the *Team* is made up of *Middle School Students* who declare themselves “playing up” as *High School Students* by registering their *Team* as a *High School Team*.
- Once a *Team* has competed in an event as a *High School Team*, that *Team* may not change back to a *Middle School Team* for the remainder of the season. *Teams* may be associated with schools, community/youth organizations, or groups of neighborhood *Students*.

In the context of this Game Manual, *Teams* contain three types of *Student* roles related to *Robot* build, design, and programming. See <G2> and <G4> for more information. *Adults* may not fulfill any of these roles.

- **Builder** – The *Student(s)* on the *Team* who assemble(s) the *Robot*. *Adults* are permitted to teach the *Builder(s)* how to use concepts or tools associated with *Robot* construction, but may never work on the *Robot* without the *Builder(s)* present and actively participating.
- **Designer** – The *Student(s)* on the *Team* who design(s) the *Robot*. *Adults* are permitted to teach the *Designer(s)* how to use concepts or tools associated with design, but may never work on the design of the *Robot* without the *Designer(s)* present and actively participating.
- **Programmer** – The *Student(s)* on the *Team* who write(s) the computer code that is downloaded onto the *Robot*. *Adults* are permitted to teach the *Programmer(s)* how to use concepts or tools associated with programming, but may never work on the code that goes on the *Robot* without the *Programmer(s)* present and actively participating.

Violation – The act of breaking a rule in the Game Manual.

Minor Violation – A *Violation* which does not result in a *Disqualification*.

- Accidental, momentary, or otherwise non *Match Affecting Violations* are usually *Minor Violations*.
- *Minor Violations* usually result in a verbal warning from the *Head Referee* during the *Match*, which should serve to inform the *Team* that a rule is being *Violated* before it escalates to a *Major Violation*.

Major Violation – A *Violation* which results in a *Disqualification*.

- Unless otherwise noted in a rule, all *Match Affecting Violations* are *Major Violations*.
- If noted in the rule, egregious or intentional *Violations* may also be *Major Violations*.
- Multiple *Minor Violations* within a *Match* or tournament may escalate to a *Major Violation* at the *Head Referee*'s discretion.

Match Affecting – A *Violation* which changes the winning and losing *Alliance* in the *Match*.

- Multiple *Violations* within a *Match* can cumulatively become *Match Affecting*.
- When evaluating if a *Violation* was *Match Affecting*, *Head Referees* will focus primarily on any *Robot* actions that were directly related to the *Violation*.
- Determining whether a *Violation* was *Match Affecting* can only be done once the *Match* is complete and the scores have been calculated.

Some rules include *Violation Notes* in *red italicized text* to denote special circumstances or provide additional clarifications. If no *Violation Notes* are found in a given rule, then it should be assumed that the above "default" definitions apply.

To determine whether a *Violation* may have been *Match Affecting*, check whether the *Team* who committed the *Violation* won or lost the *Match*. If they did not win the *Match*, then the *Violation* could not have been *Match Affecting*, and it was very likely a *Minor Violation*.

See the flowchart in Figure 3 for more information.

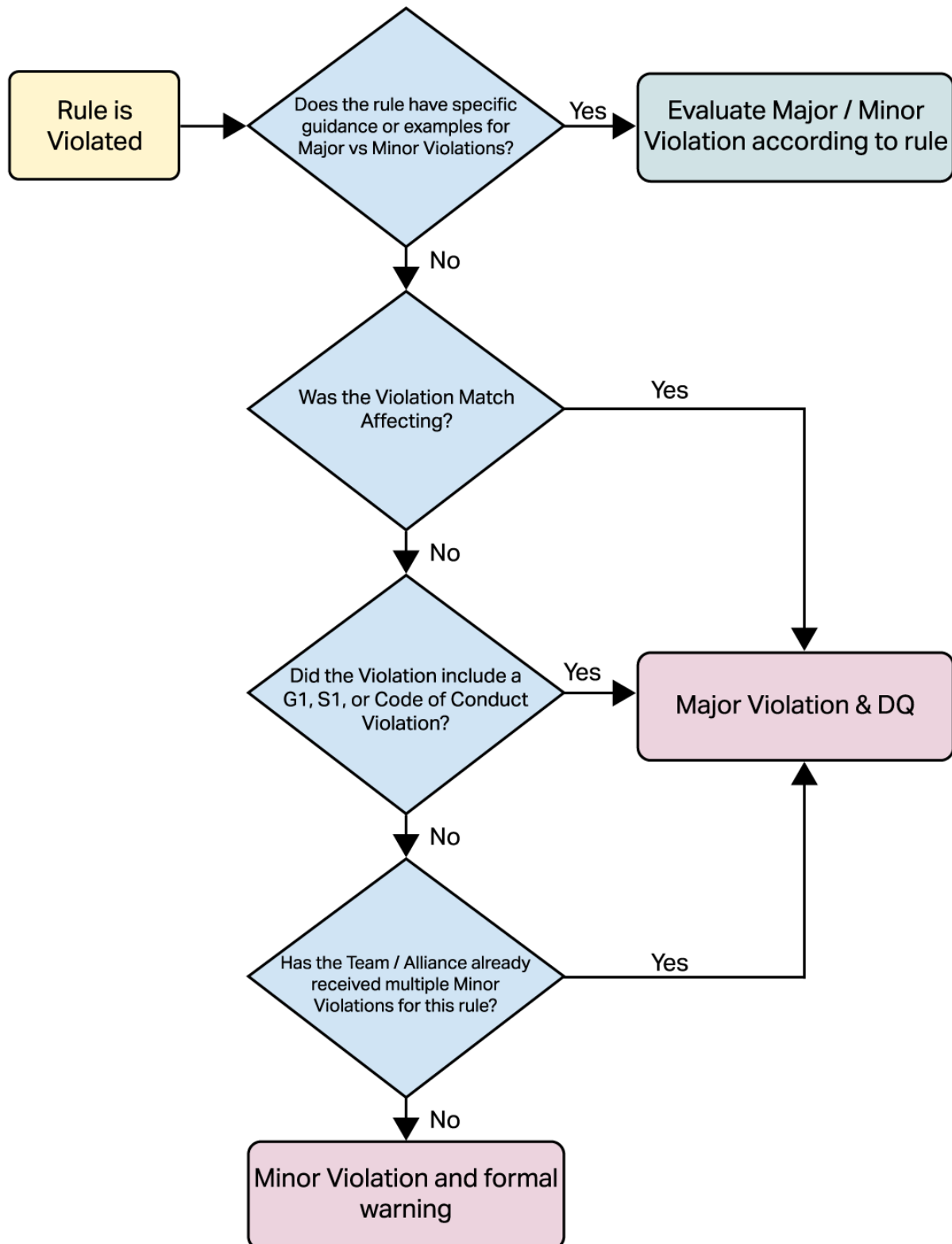

Figure 3: The process for determining whether or not an infraction should result in a Major Violation or Minor Violation.

Game-Specific Definitions

Alliance Triball – One of four *Triballs*, two per *Alliance*, that are *Alliance*-colored instead of green. *Alliance Triballs* may be used as *Preloads* or *Match Loads*.

Barrier – The black structure, made up of 2" Schedule 40 PVC pipe (with a 2.375" outer diameter) PVC pipe and associated connectors/hardware, that sits in the middle of the field. For some rules, the *Barrier* is divided into one *Long Barrier* and two *Short Barriers*, but it is usually referred to collectively as just "the *Barrier*."

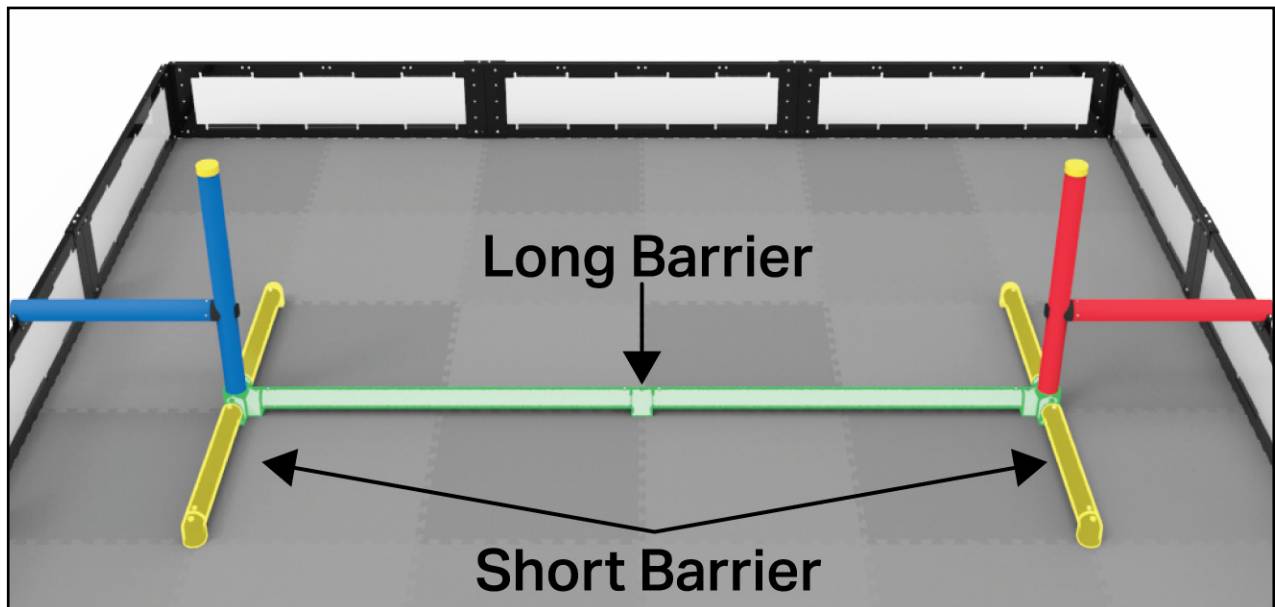

Figure 4: A view of the field, with the Short Barriers (yellow) and Long Barrier (green) highlighted.

Double-Zone – An *Alliance* status. An *Alliance* meets the definition of being "Double-Zoned" if both *Robots* from the *Alliance* are in the same *Offensive Zone*. To be considered "in the Zone" for the purposes of this definition, *Robots* must meet the following criteria:

1. Contacting the gray tiles within the Zone
2. Not contacting the *Long Barrier*
3. Not contacting any *Elevation Bars*

Elevated – A *Robot* status. A *Robot* is considered *Elevated* at the end of the *Match* if it meets the following criteria:

1. The *Robot* is contacting at least one of the following:
 - a. One or more of their *Alliance's Elevation Bars*
 - b. The *Barrier*
 - c. An *Alliance* partner *Robot* which meets the requirements of points 1-3 in this definition
2. The *Robot* is not contacting any *Field Elements* other than those listed in point 1. This includes gray field tiles, the field perimeter, *Goals*, the opposing *Alliance's Elevation Bar*, etc.
 - a. Contact with (or Possession of) *Triballs* is irrelevant when determining a *Robot's Elevated* status.
3. The *Robot* is not contacting the yellow *Elevation Bar Cap*.

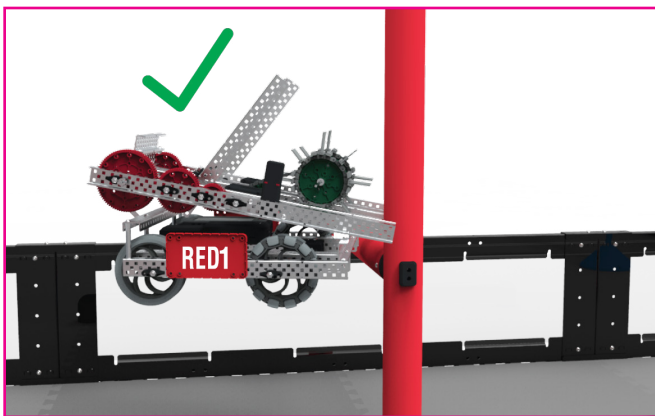

Figure 5: This *Robot* would be considered as *Elevated*, because it meets all the criteria listed above.

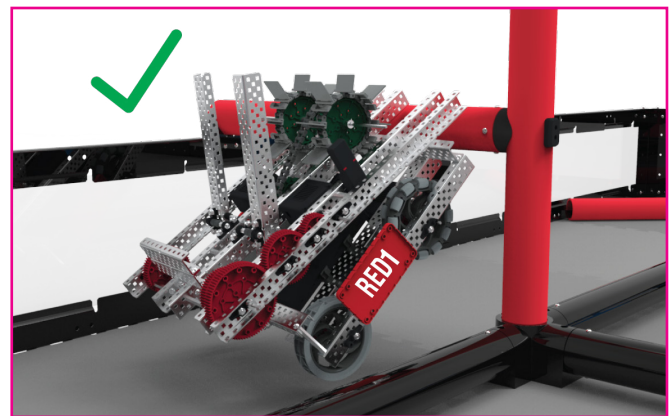

Figure 6: This *Robot* would be considered as *Elevated*, because it meets all the criteria listed above.

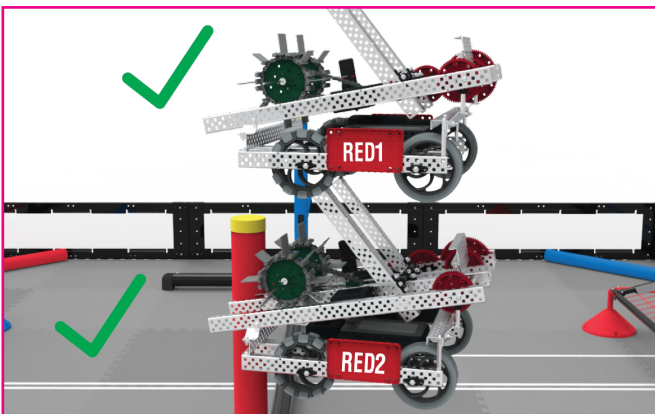

Figure 7: Both *Robots* would be considered as *Elevated*, because they meet all the criteria listed above.

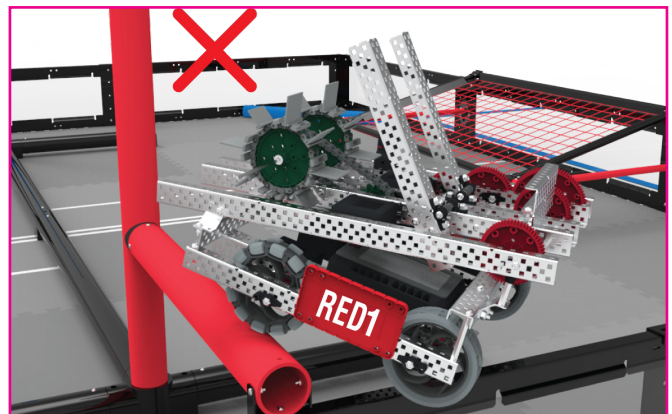

Figure 8: This *Robot* would not be considered as *Elevated*, because it is in contact with the field perimeter.

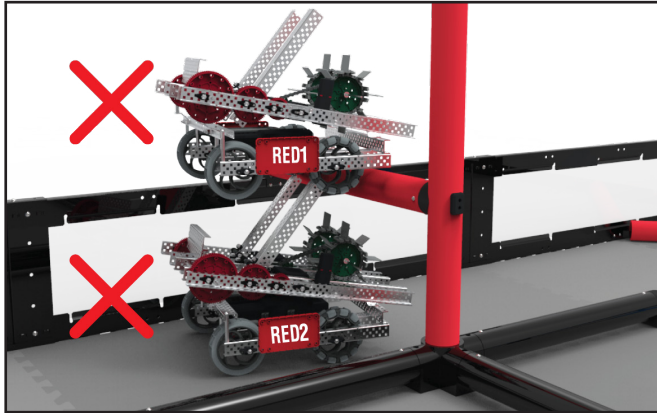

Figure 9: Red Robot 1 is in contact with Red Robot 2, which is still in contact with the field tiles. Therefore, neither Robot would be considered as Elevated.

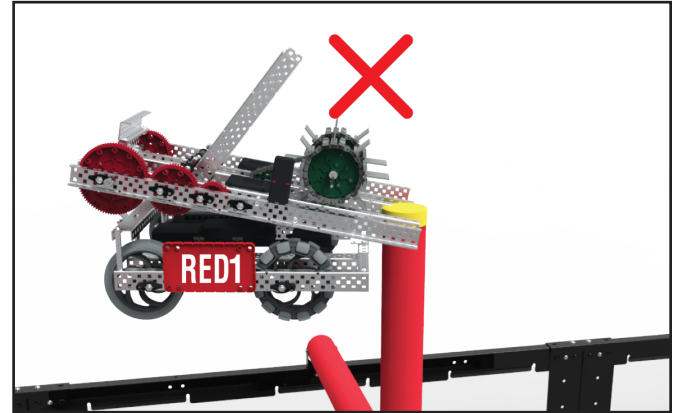

Figure 10: This Robot would not be considered as Elevated, because it is in contact with the Elevation Bar Cap.

Elevation Bar – The *Alliance*-colored PVC pipes, two red and two blue, at either end of the *Barrier*.

Elevation Bar Cap – The yellow plastic piece at the top of each set of *Elevation Bars*. The *Elevation Bar Cap* is a separate field element and is not considered part of the *Elevation Bar*.

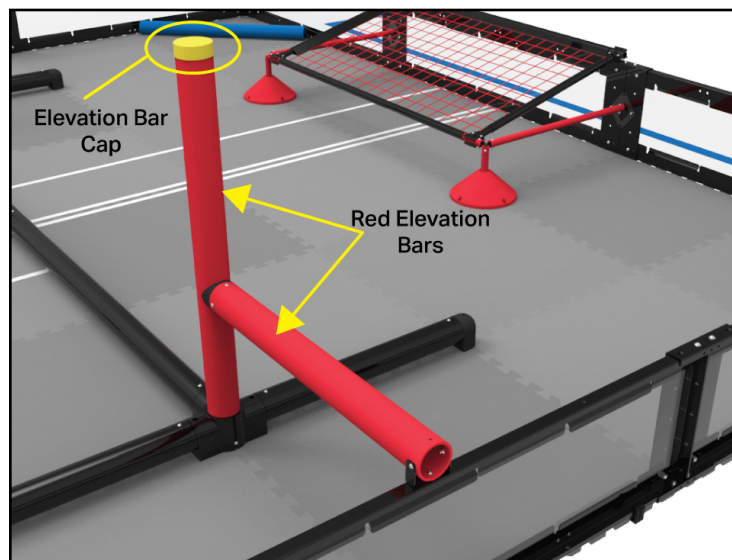

Figure 11: An Elevation Bar and Elevation Bar Cap.

Elevation Tier – A status that represents an *Elevated Robot's* height off of the field at the end of the *Match*. A *Robot's Elevation Tier* is measured by placing the *Height Guide* vertically next to an *Elevated Robot* and determining which letter-labeled segment of the *Height Guide* the lowest point of the *Robot* falls within. See Figure 17.

Note: There are no additional *Elevation Tiers* above the *Height Guide*. Robots which end the *Match* above the *Height Guide* will be considered to be at the maximum, *Elevation Tier J*.

Note 2: Robots that are not *Elevated* do not receive an *Elevation Tier*.

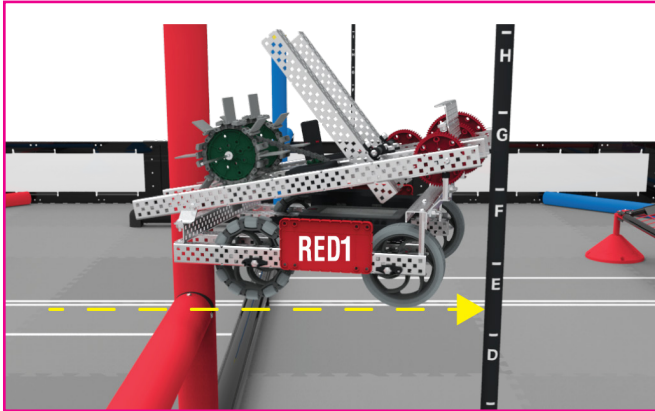

Figure 12: This Robot would be considered to be in Elevation Tier E.

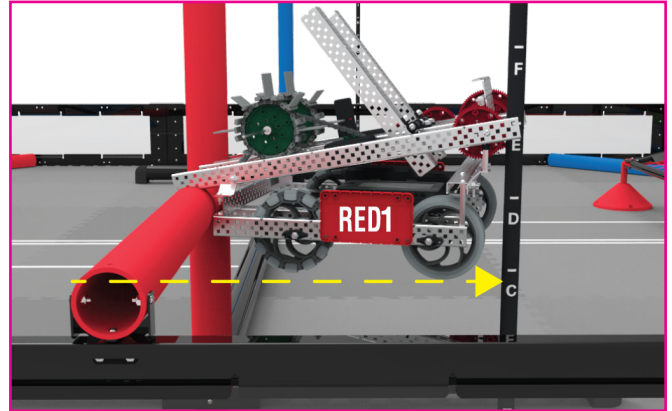

Figure 13: This Robot would be considered to be in Elevation Tier C.

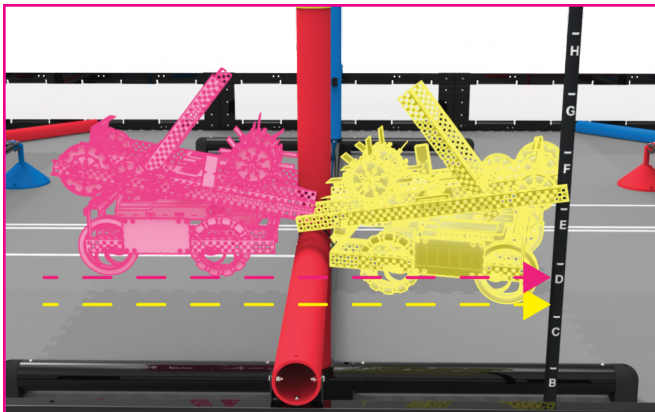

Figure 14: Even though the pink highlighted Robot is slightly higher than the yellow highlighted Robot, they would both still be considered in Elevation Tier D.

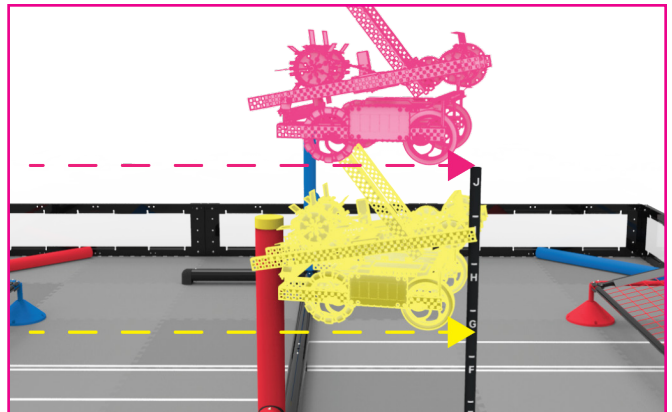

Figure 15: The yellow highlighted Robot would be considered in Elevation Tier G. The pink highlighted Robot would be considered in Elevation Tier J, as there is no higher Tier.

Goal – The *Alliance*-colored, netted structure on either side of the field, one red and one blue, into which *Triballs* can be scored for points.

As a Field Element, the term “*Goal*” refers to the net and all supporting structures / hardware (e.g. PVC pipes and plastic bases).

For the purposes of scoring, the “*Goal*” refers specifically to the three-dimensional volume bounded by a vertical projection of the outermost PVC pipes onto the field and below the surface of the net.

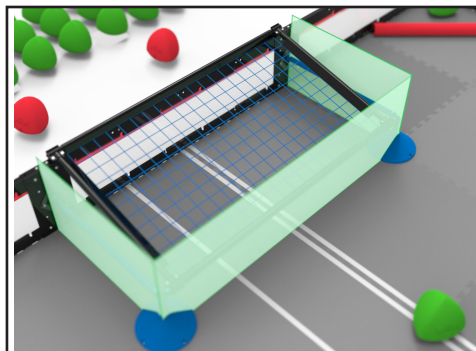

Figure 16: A Goal. The three-dimensional outer scoring boundaries are highlighted in green.

Height Guide – The black PVC pipe, roughly 0.84" in diameter and 36" long, which is labeled with white-printed lettered segments of approximately 3.6" each. The Height Guide is used by Referees to determine *Elevation Tiers* at the end of a *Match*. The *Height Guide* is a tool, not a Field Element.

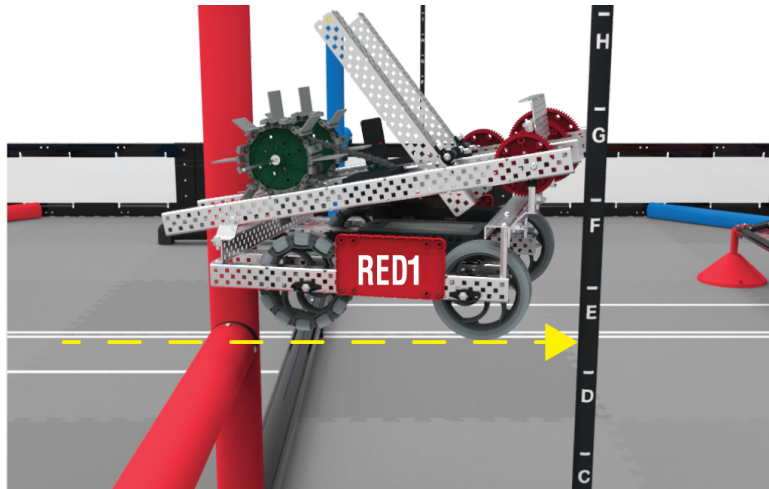

Figure 17: An example of how the Height Guide would be used to determine a Robot's Elevation Tier.

Match Load Bar – The *Alliance*-colored structure, made up of 2" Schedule 40 PVC pipe (with a 2.375" outer diameter) and associated connectors/hardware, that connects diagonally across a corner of the Field.

Match Load Zone – The portion of the floor tile bordered by a *Match Load Bar* and an inside corner of the Field Perimeter.

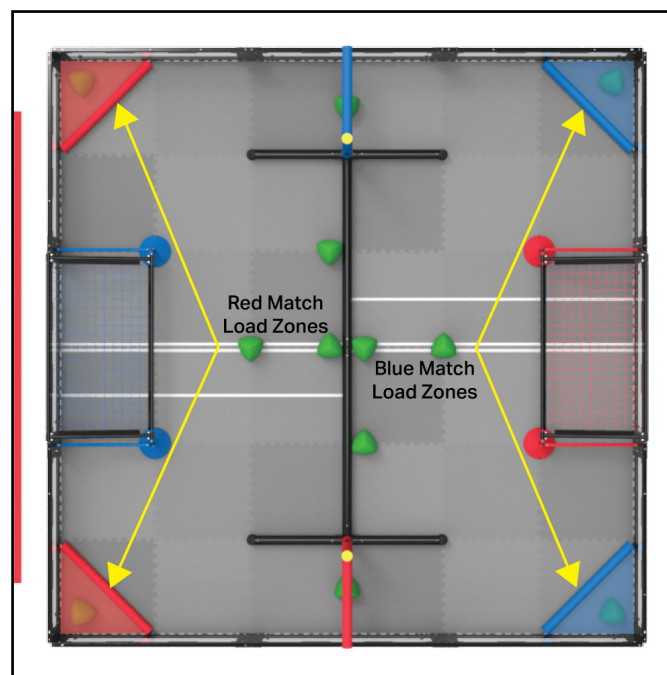

Figure 18: The four (4) Match Load Zones found on a VRC Over Under Field.

Neutral Zone – One of two areas of the field bordered by white tape lines, the *Barrier*, and the field perimeter. The *Neutral Zone* is defined as the gray foam tiles themselves; it is not a 3-dimensional volume.

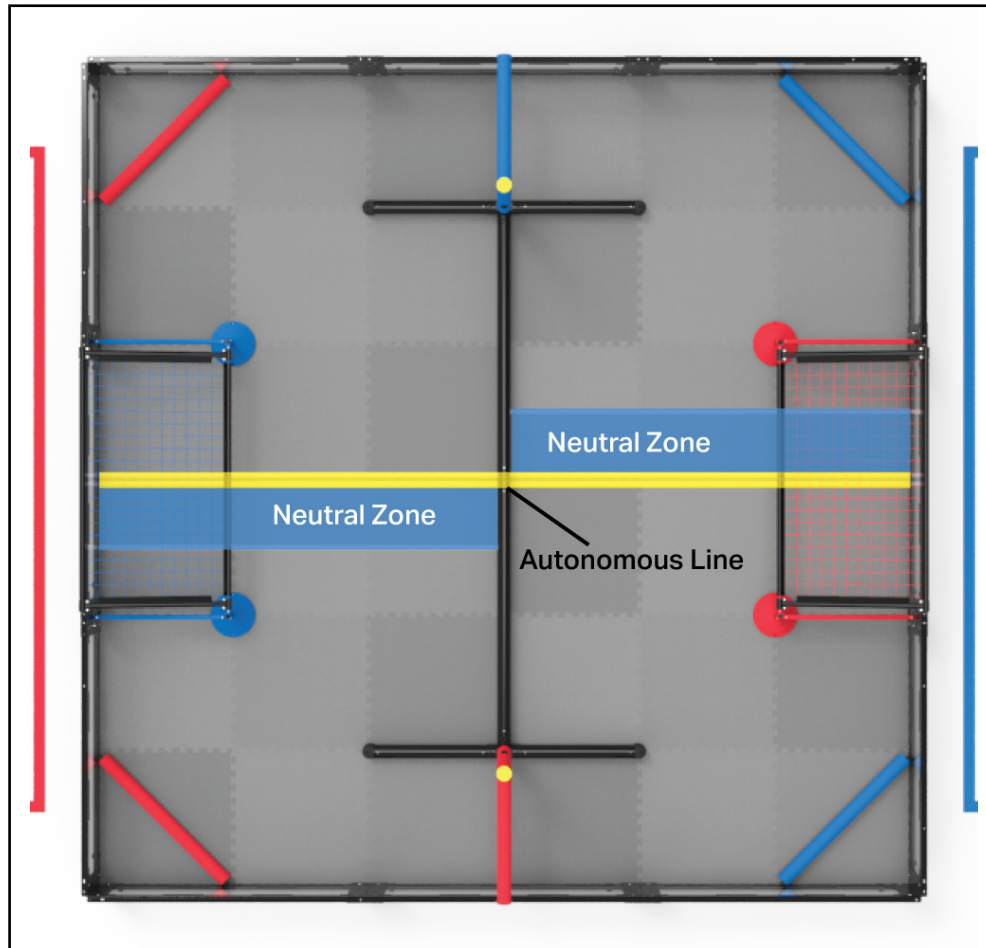

Figure 19: A depiction of the Neutral Zone (blue) and Autonomous Line (yellow) and their boundaries.

Offensive Zone – One of two halves of the field, divided by the *Barrier*. See Figure 20.

- Each *Alliance* has an *Offensive Zone*. An *Alliance's Offensive Zone* is on the side furthest from their *Alliance Station* and closest to that *Alliance's* colored *Goal*.
- Each *Offensive Zone* consists of the gray foam tiles on one side of the *Barrier*. It is not a 3-dimensional volume.
- The Long *Barrier* is not considered to be in either *Offensive Zone*.
- The *Match Load Zones* are not considered to be part of either *Offensive Zone*.

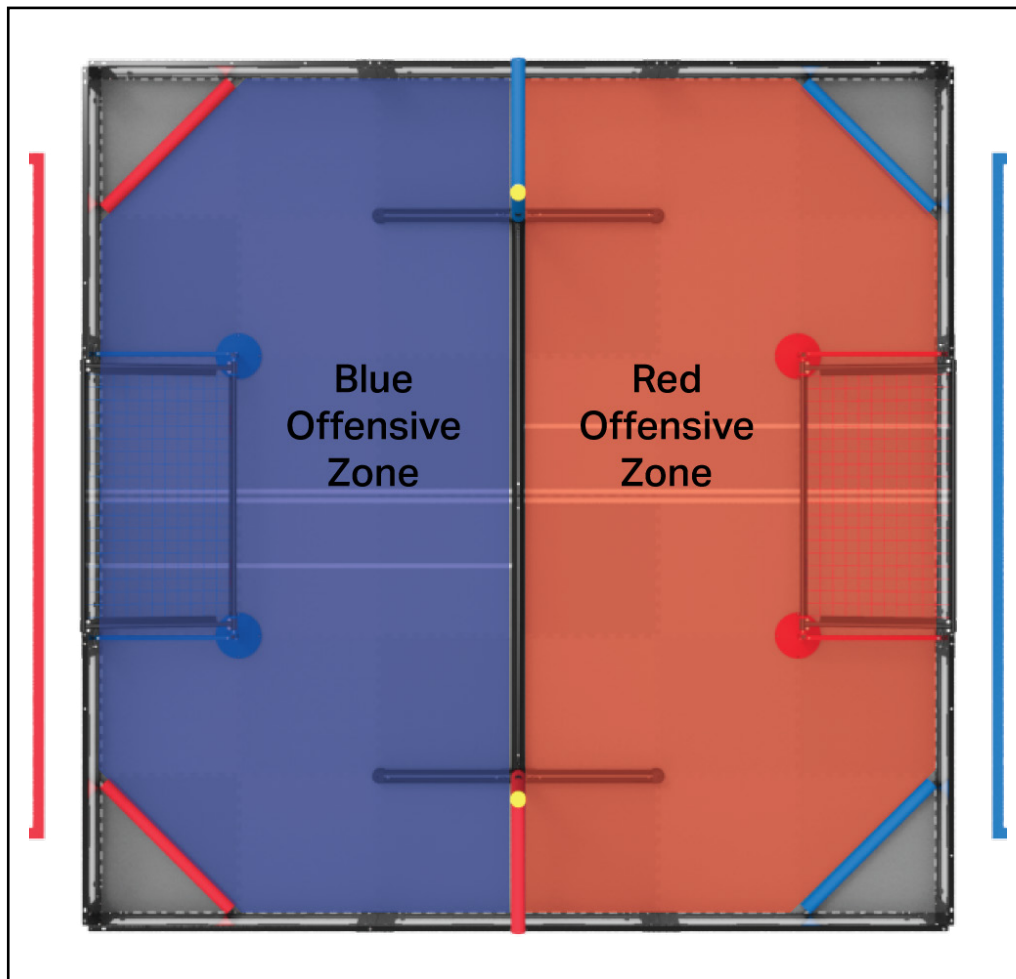

Figure 20: A depiction of the two Offensive Zones and their boundaries.

Possession – A Robot / Triball status. A Robot is considered to be in *Possession* of a Triball if the Robot is carrying, holding, or controlling the movement of a Triball such that if the Robot changes direction, the Triball will move with the Robot. Therefore, pushing/plowing Triballs is not considered *Possession*; however, using concave portions of a Robot to control the movement of Triballs is considered *Possession*.

Preload – An Alliance Triball, when loaded into a Robot prior to a Match. See <SG4>.

Scored – A Triball status. See the Scoring section.

Starting Tile – One of the gray foam tiles along the edge of the field perimeter to the right of each Alliance Station. See <SG1>.

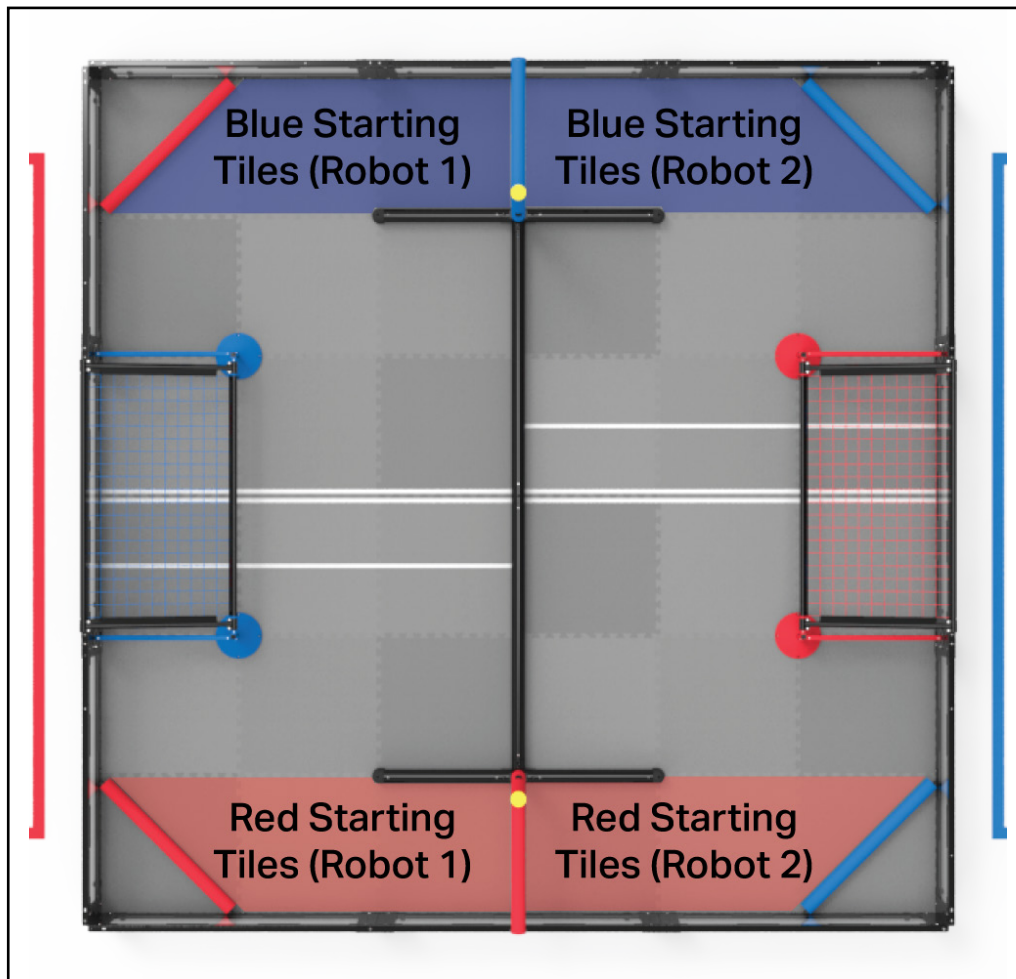

Figure 21: A depiction of the Robot Starting Tiles and their boundaries.

Triball – A green, red, or blue plastic scoring object with a slightly rounded triangular pyramidal shape known as a Reuleaux triangle. Each *Triball* is approximately 6.18" tall with a weight of 103-138g.



Figure 22: The three (3) colors of Triballs used in a VRC Over Under Match.

Scoring

<i>Autonomous Bonus</i>	8 Points
Each <i>Triball</i> Scored in a Goal	5 Points
Each <i>Triball</i> Scored in an <i>Offensive Zone</i>	2 Points
Elevation - Top Tier	20 Points
Elevation - 2nd Tier	15 Points
Elevation - 3rd Tier	10 Points
Elevation - 4th Tier	5 Points

<SC1> All Scoring statuses are evaluated **after the Match ends**. Scores are calculated once all *Triballs*, Field Elements, and *Robots* on the field come to rest.

<SC2> Scoring of the **Autonomous Bonus** is evaluated immediately after the *Autonomous Period* ends (i.e., once all *Triballs*, Field Elements, and *Robots* on the field come to rest).

- Elevation Tier* points are not included in the calculation of an *Alliance's* score for the purposes of determining the *Autonomous Bonus*.
- If the *Autonomous Period* ends in a tie, including a zero-to-zero tie, each *Alliance* will receive an *Autonomous Bonus* of four (4) points.

<SC3> A *Triball* is considered **Scored in a Goal** if it meets the following criteria:

- The *Triball* is not contacting a *Robot* of the same color *Alliance* as the *Goal*.
- At least two (2) corners of the *Triball* are within the *Goal* (i.e., are under the Net and have "broken the plane" of the outer edge of the PVC pipes that define the *Goal* volume).

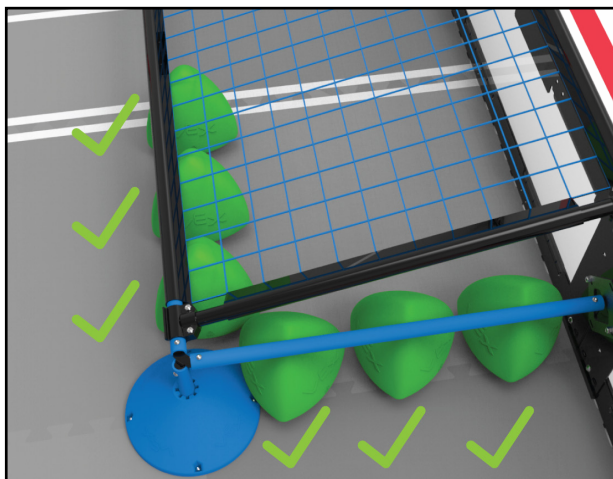

Figure 23: All of these *Triballs* would be considered as Scored, because two or more of the "Corners" are within the boundary of the *Goal*.

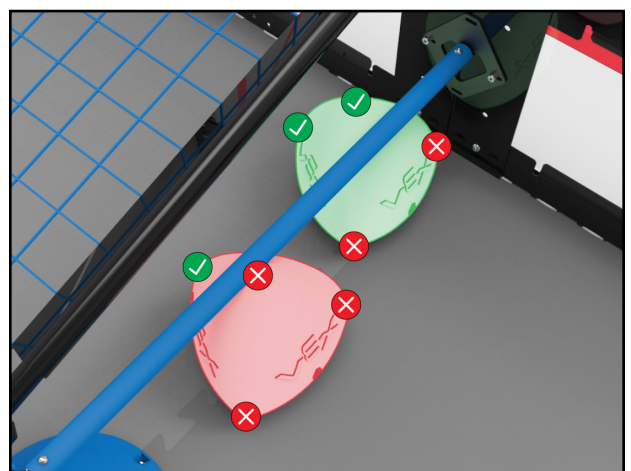

Figure 24: The green highlighted *Triball* would be considered as Scored, because 2 or more of the "Corners" are within the boundary of the *Goal*. The red highlighted *Triball* would not be considered as Scored, because only one "corner" is within the boundary.

<SC4> A *Triball* is considered **Scored in an Offensive Zone** if it meets the following criteria:

- a. The *Triball* is not contacting a *Robot* of the same color *Alliance* as the *Offensive Zone*.
- b. The *Triball* is contacting the gray foam tiles within the *Offensive Zone*.

Note: Offensive Zone scoring is based on contact with the gray foam tiles in each Offensive Zone. In the case of any close calls, referees may use a "paper test" (i.e. gently slide a piece of paper under the Triball) to determine which Offensive Zone it should be scored in. If the Triball is contacting both Offensive Zones, then it is not considered Scored in either Zone. See Figure 23.

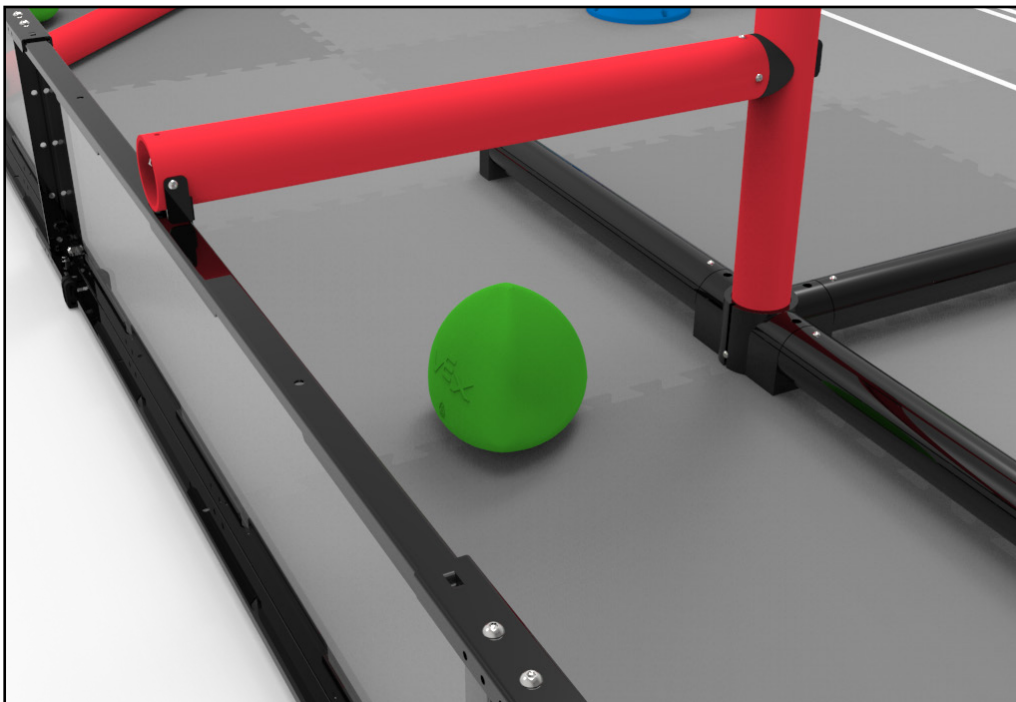

Figure 25: This Triball would not be considered as Scored in either Offensive Zone, because it is touching both zones.

<SC5> **Alliance Triballs** may be Scored in any *Goal* or *Offensive Zone*, and always count toward the same color *Alliance* as the *Triball*. For example, a red *Alliance Triball* that meets the definition of Scored in the blue *Goal* will count as 5 points for the red *Alliance*.

- a. To be eligible for points, *Alliance Triballs* must not be contacting any *Robots* of the same color *Alliance* as the *Triball*.
- b. Rule <SC3a> does not apply to *Alliance Triballs*.

<SC6> **Elevation points** are comparative, and are awarded based on the *Elevation Tiers* achieved by all *Robots* at the end of the *Match*. The highest-*Elevated Robot* will receive the highest number of Elevation points, followed by the second-highest, and so on. If multiple *Robots* are measured at the same *Elevation Tier*, they will receive the same amount of points.

Example 1		
Robot	Elevation Tier	Points
Red 1	C	2nd Tier (15)
Red 2	D	Top Tier (20)
Blue 1	A	4th Tier (5)
Blue 2	B	3rd Tier (10)

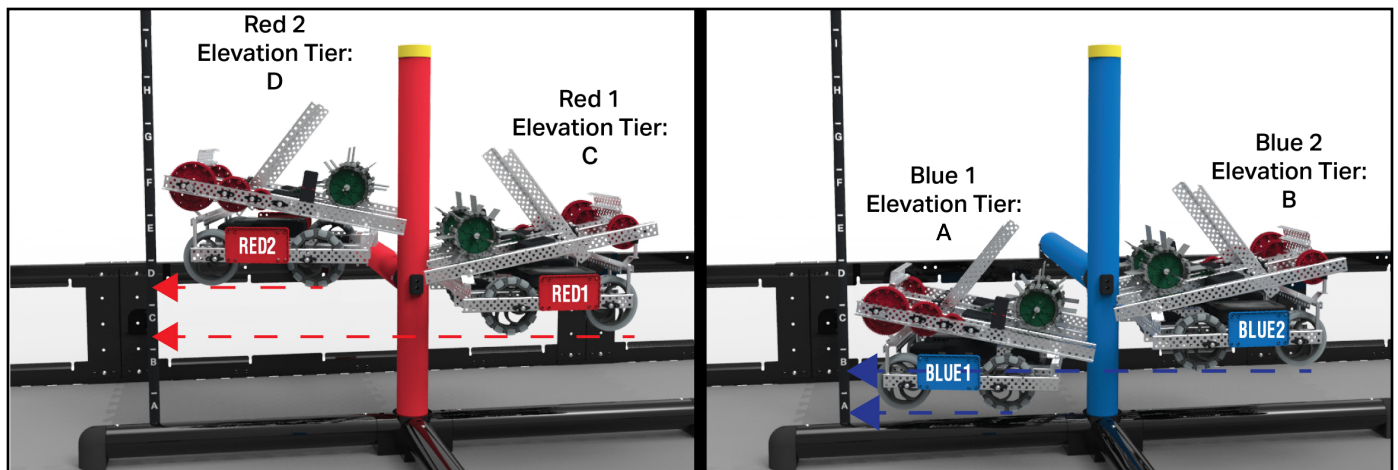

Example 2		
Robot	Elevation Tier	Points
Red 1	None	0
Red 2	F	Top Tier (20)
Blue 1	F	Top Tier (20)
Blue 2	C	2nd Tier (15)

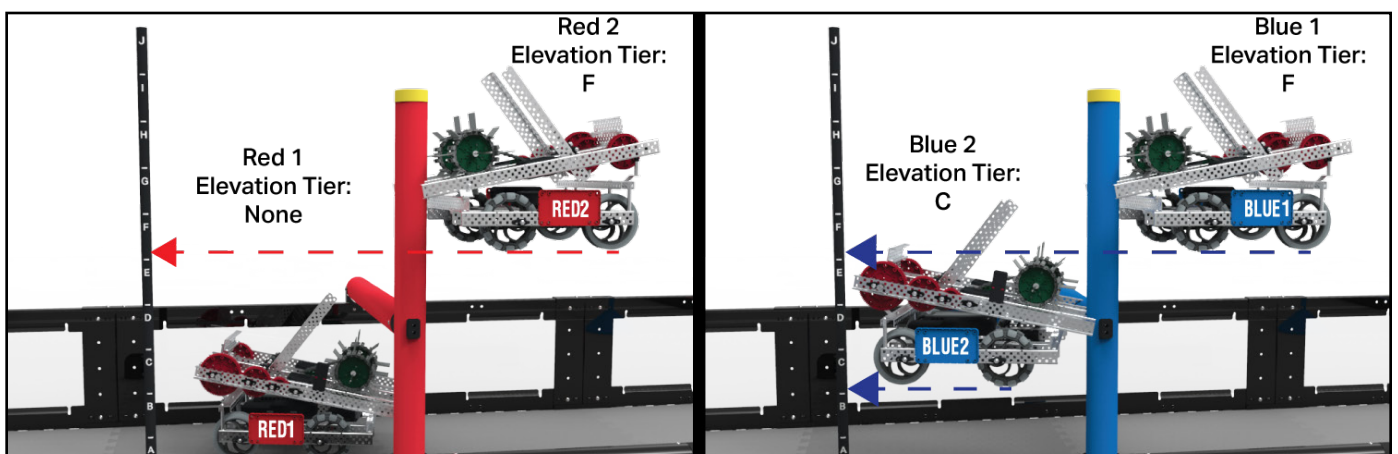

<SC7> An **Autonomous Win Point** is awarded to any *Alliance* that has completed the following tasks at the end of the *Autonomous Period*:

- a. Removed the *Triball* from the *Alliance's Match Load Zone* that coincides with their *Starting Tiles*. For example, in Figure 18, the red *Alliance* must remove the *Triball* that begins in the bottom-left *Match Load Zone*, adjacent to *Robot 1's Starting Tiles*.
- b. Scored at least one *Alliance Triball* in the *Alliance's own Goal*.
- c. Ended the *Autonomous Period* with at least one *Robot* contacting their own *Elevation Bar*.
- d. Not violated any other rules.

Safety Rules

<S1> Be safe out there. If at any time the *Robot* operation or *Team* actions are deemed unsafe or have damaged a Field Element or *Triball*, the offending *Team* may receive a *Disablement* and/or *Disqualification* at the discretion of the *Head Referee*. The *Robot* will require re-inspection as described in rule <R3> before it may take the field again.

<S2> Students must be accompanied by an Adult. No *Student* may attend a VRC event without a responsible *Adult* supervising them. The *Adult* must obey all rules and be careful to not violate Student-centered policies, but must be present at the event in the case of an emergency. *Violations* of this rule may result in removal from the event.

<S3> Stay inside the field. If a *Robot* is completely out-of-bounds (outside the playing field), it will be *Disabled* for the remainder of the *Match*.

Note: The intent of this rule is not to penalize Robots for having mechanisms that inadvertently cross the field perimeter during normal game play. However, mechanisms which cross the field perimeter intentionally and/or repeatedly while interacting with the Match Load Zone may be considered a Violation of <S1> at the Head Referee's discretion.

<S4> Wear safety glasses. All *Drive Team Members* must wear safety glasses or glasses with side shields while in the *Alliance Stations* during *Matches*. While in the pit area, it is highly recommended that all *Team* members wear safety glasses.

General Game Rules

<G1> Treat everyone with respect. All *Teams* are expected to conduct themselves in a respectful and professional manner while competing in VEX Robotics Competition events. If a *Team* or any of its members (*Students* or any *Adults* associated with the *Team*) are disrespectful or uncivil to event staff, volunteers, or fellow competitors, they may be *Disqualified* from a current or upcoming *Match*. *Team* conduct pertaining to <G1> may also impact a *Team's* eligibility for judged awards. Repeated or extreme violations of <G1> could result in a *Team* being *Disqualified* from an entire event, depending on the severity of the situation.

We all can contribute to creating a fun and inclusive event experience for all event attendees. Some examples include:

When dealing with difficult and stressful situations, it is...

- Okay for *Teams* to be gracious and supportive when your *Alliance* partner makes a mistake.
- Not okay for *Teams* to harass, tease, or be disrespectful to your *Alliance* partner when a *Match* does not go your way.

When a *Team* does not understand a *Match* ruling or score, it is...

- Okay for *Drive Team Members* to consult with a *Head Referee* to discuss a ruling per the process outlined in <T3> in a calm and respectful manner.
- Not okay for *Drive Team Members* to continue arguing with the *Head Referees* after a decision has been finalized, or for *Adults* to approach a *Head Referee* with ruling/ scoring concerns.

When *Teams* are getting ready for an upcoming *Match*, it is...

- Okay for *Teams* in an *Alliance* to develop a game strategy that utilizes the strengths of both *Robots* to cooperatively solve the game.
- Not okay for *Teams* in an *Alliance* to intentionally play beneath their abilities to manipulate the *Match* results.

This rule exists alongside the REC Foundation Code of Conduct. Violation of the Code of Conduct can be considered a *Major Violation* of <G1> and can result in *Disqualification* from a current *Match*, an upcoming *Match*, an entire event, or (in extreme cases) an entire competition season. The Code of Conduct can be found at <https://vrc-kb.recf.org/hc/en-us/articles/9653987780375-Code-of-Conduct>.

Violation Notes: All Violations of <G1> are considered Major Violations and should be addressed on a case-by-case basis. Teams at risk of a <G1> Violation due to multiple disrespectful or uncivil behaviors will usually receive a "final warning", although the Head Referee is not required to provide one.

<G2> **VRC is a student-centered program.** *Adults* may assist *Students* in urgent situations, but *Adults* may never work on or program a *Robot* without *Students* on that *Team* being present and actively participating. *Students* must be prepared to demonstrate an active understanding of their *Robot's* construction and programming to judges or event staff.

Some amount of *Adult* mentorship, teaching, and/or guidance is an expected and encouraged facet of VEX competitions. No one is born an expert in robotics! However, obstacles should always be viewed as teaching opportunities, not tasks for an *Adult* to solve without *Students* present and actively participating.

When a mechanism falls off, it is...

- Okay for an *Adult* to help a *Student* investigate why it failed, so it can be improved.
- Not okay for an *Adult* to put the *Robot* back together.

When a *Team* encounters a complex programming concept, it is...

- Okay for an *Adult* to guide a *Student* through a flowchart to understand its logic.
- Not okay for an *Adult* to write a premade command for that *Student* to copy/paste.

During *Match* play, it is...

- Okay for an *Adult* to provide cheerful, positive encouragement as a spectator.
- Not okay for an *Adult* to explicitly shout step-by-step commands from the audience.

This rule operates in tandem with the REC Foundation Student Centered Policy, which is available on the REC Foundation website for *Teams* to reference throughout the season:

<https://vrc-kb.recf.org/hc/en-us/articles/9654578622487-Student-Centered-Policy->

Violation Notes: Potential Violations of this rule will be reviewed on a case-by-case basis. By definition, all Violations of this rule become Match Affecting as soon as a Robot which was built by an Adult wins a Match.

<G3> Use common sense. When reading and applying the various rules in this document, please remember that common sense always applies in the VEX Robotics Competition.

For example...

- If there is an obvious typographical error (such as “per <T5>” instead of “per <G5>”), this does not mean that the error should be taken literally until corrected in a future update.
- Understand the realities of the VEX V5 *Robot* construction system. For example, if a *Robot* could hover above the Field for a whole *Match*, that would create loopholes in many of the rules. But... they can't. So don't worry about it.
- When in doubt, if there is no rule prohibiting an action, it is generally legal. However, if you have to ask whether a given action would violate <S1>, <G1>, or <T1>, then that's probably a good indication that it is outside the spirit of the competition.
- In general, *Teams* will be given the “benefit of the doubt” in the case of accidental or edge-case rules infractions. However, there is a limit to this allowance, and repeated or strategic infractions will still be penalized.
- This rule also applies to *Robot* rules. If a component's legality cannot be easily / intuitively discerned by the Robot rules as written, then *Teams* should expect additional scrutiny during inspection. This especially applies to those rules which govern non-VEX components (e.g. <R6>, <R7>, <R8>, etc). There is a difference between “creativity” and “lawyering”.

<G4> The Robot must represent the skill level of the Team. Each *Team* must include *Drive Team Members*, *Programmer(s)*, *Designer(s)*, and *Builder(s)*. No *Student* may fulfill any of these roles for more than one VEX Robotics Competition *Team* in a given competition season. *Students* may have more than one role on the *Team*, e.g. the *Designer* may also be the *Builder*, the *Programmer* and a *Drive Team Member*.

- a. *Team* members may move from one *Team* to another for non-strategic reasons outside of the *Team's* control.
 - i. Examples of permissible moves may include, but are not limited to, illness, changing schools, conflicts within a *Team*, or combining/splitting *Teams*.
 - ii. Examples of strategic moves in *Violation* of this rule may include, but are not limited to, one *Programmer* "switching" *Teams* in order to write the same program for multiple *Robots*, or one *Student* writing the Engineering Notebook for multiple *Teams*.
 - iii. If a *Student* leaves a *Team* to join another *Team*, <G4> still applies to the *Students* remaining on the previous *Team*. For example, if a *Programmer* leaves a *Team*, then that *Team's Robot* must still represent the skill level of the *Team* without that *Programmer*. One way to accomplish this would be to ensure that the *Programmer* teaches or trains a "replacement" *Programmer* in their absence.
- b. When a *Team* qualifies for a Championship event (e.g., States, Nationals, Worlds, etc.) the *Students* on the *Team* attending the Championship event are expected to be the same *Students* on the *Team* that was awarded the spot. *Students* can be added as support to the *Team*, but may not be added as *Drive Team Members* or *Programmer* for the *Team*.
 - i. An exception is allowed if one (1) *Drive Team Member* and / or one (1) *Programmer* on the *Team* cannot attend the event. The *Team* can make a single substitution of a *Drive Team Member* or *Programmer* for the Championship event with another *Student*, even if that *Student* has competed on a different *Team*. This *Student* will now be on this new *Team* and may not substitute back to the original *Team*.

Violation Notes: Violations of this rule will be evaluated on a case-by-case basis, in tandem with the REC Foundation Student Centered Policy as noted in <G2>, and the REC Foundation Code of Conduct as noted in <G1>.

Event Partners should bear in mind <G3>, and use common sense when enforcing this rule. It is not the intent to punish a *Team* who may change *Team* members over the course of a season due to illness, changing schools, conflicts within a *Team*, etc.

Event Partners and referees are not expected to keep a roster of any *Student* who has ever been a *Drive Team Member* for one day. This rule is intended to block any instance of loaning or sharing *Team* members for the sole purpose of gaining a competitive advantage.

<G5> Robots begin the Match in the starting volume. At the beginning of a *Match*, each *Robot* must be smaller than a volume of 18" (457.2 mm) long by 18" (457.2 mm) wide by 18" (457.2 mm) tall. Using Field Elements, such as the field perimeter wall, to maintain starting size is only acceptable if the *Robot* would still satisfy the constraints of <R4> and pass inspection without the Field Elements.

Violation Notes: Any Violation of this rule will result in the Robot being removed from the field prior to the start of the Match, and rules <R3d> and <T5> will apply until the situation is corrected.

<G6> Keep your Robots together. Robots may not intentionally detach parts during the *Match* or leave mechanisms on the field.

Note: Parts which become detached unintentionally and therefore a Minor Violation are no longer considered "part of a Robot," and should be ignored for the purposes of any rules which involve Robot contact or location (e.g., Scoring, Double-Zone, etc.) or Robot size.

Violation Notes: Major Violations of this rule should be rare, as Robots should never be designed to intentionally violate it. Minor Violations are usually due to Robots being damaged during gameplay, such as a wheel falling off.

<G7> Don't clamp your Robot to the field. Robots may not intentionally grasp, grapple, or attach to any Field Elements other than the *Elevation Bars*. Strategies with mechanisms that react against multiple sides of a Field Element in an effort to latch or clamp onto said Field Element are prohibited. The intent of this rule is to prevent *Teams* from both unintentionally damaging the field and/or from anchoring themselves to the field in locations other than the *Elevation Bars*.

Violation Notes: Major Violations of this rule should be rare, as Robots should never be designed to intentionally violate it.

<G8> Only Drivers, and only in the Alliance Station. During a *Match*, each *Team* may have up to three (3) *Drive Team Members* in their *Alliance Station*, and all *Drive Team Members* must remain in their *Alliance Station* for the duration of the *Match*.

Drive Team Members are prohibited from any of the following actions during a *Match*:

- a. Bringing/using any sort of communication devices into the *Alliance Station*. Devices with communication features turned off (e.g., a phone in airplane mode) are allowed.
- b. Standing on any sort of object during a *Match*, regardless of whether the field is on the floor or elevated.
- c. Bringing/using additional materials to simplify the game challenge during a *Match*.

<G8c> is intended to refer to non-*Robot*-related items that directly influence gameplay, such as using a fan to influence opponent *Triballs* traveling through the air. Provided no other rules are violated, examples such as the following are not considered violations of <G8>:

- Materials used before or after a *Match*, such as a pre-*Match* alignment aid, or a carrying case for *Robots/Controllers*
- Strategic aids, such as a whiteboard or clipboard
- Earplugs, gloves, or other personal accessories

Note: Drive Team Members are the only Team members that are allowed to be in the Alliance Station during a Match.

Note 2: During a Match, Robots may be operated only by the Drive Team Members and/or by software running on the Robot's control system, in accordance with <R26> and <G10>.

Violation Notes: Major Violations of this rule are not required to be Match Affecting, and could invoke Violations of other rules, such as <G1>, <G2>, or <G4>.

<G9> Hands out of the field. *Drive Team Members* are prohibited from making intentional contact with any *Triballs*, Field Elements, or *Robots* during a *Match*, apart from the contact specified in <G9a>.

- a. During the *Driver Controlled Period*, *Drive Team Members* may only touch their own *Robot* if the *Robot* has not moved at all during the *Match*. Touching the *Robot* in this case is permitted only for the following reasons:
 - i. Turning the *Robot* on or off.
 - ii. Plugging in a battery.
 - iii. Plugging in a V5 Robot Radio.
 - iv. Touching the V5 Robot Brain screen, such as to start a program.
- b. *Drive Team Members* are not permitted to break the plane of the field perimeter at any time during the *Match*, apart from the actions described in <G9a>, <SG3>, and <SG6>.
- c. Transitive contact, such as contact with the field perimeter that causes the field perimeter to contact Field Elements or *Triballs* inside of the field, could be considered a *Violation* of this rule.

Note: Any concerns regarding Field Element or Triball starting positions should be raised with the Head Referee prior to the Match. Team members may never adjust the Triballs or Field Elements themselves.

<G10> Controllers must stay connected to the field. Prior to the beginning of each *Match*, *Drive Team Members* must plug their V5 Controller into the field's control system. This cable must remain plugged in for the duration of the *Match*, and may not be removed until the "all-clear" has been given for *Drive Team Members* to retrieve their *Robots*. See <T23> for more information regarding field control system options.

Violation Notes: The intent of this rule is to ensure that Robots abide by commands sent by the tournament software. Temporarily removing the cable to assist with mid-Match troubleshooting, with an Event Partner or other event technical staff present and assisting, would not be considered a Violation.

<G11> Autonomous means "no humans." During the *Autonomous Period*, *Drive Team Members* are not permitted to interact with the *Robots* in any way, directly or indirectly. This could include, but is not limited to:

- Activating any controls on their V5 Controllers
- Unplugging or otherwise manually interfering with the field connection in any way

- Manually triggering sensors (including the Vision Sensor) in any way, even without touching them

Violation Notes: See <G12>.

<G12> All rules still apply in the Autonomous Period. Teams are responsible for the actions of their Robots at all times, including during the *Autonomous Period*. Any *Violations* committed during the *Autonomous Period* that affect the outcome of the *Autonomous Bonus*—whether they are *Match Affecting* or not—will result in the *Autonomous Bonus* being automatically awarded to the opposing *Alliance*.

If both *Alliances* commit *Violations* during the *Autonomous Period* that would have affected the outcome of the *Autonomous Bonus*, then no *Autonomous Bonus* will be awarded.

Violation Notes: The intent of this rule is to provide retribution for Violations committed during the Autonomous Period that are not Match Affecting, and therefore not Major Violations, but do affect the outcome of the Autonomous Bonus.

<G13> Don't destroy other Robots. But, be prepared to encounter defense. Strategies aimed solely at the destruction, damage, tipping over, or *Entanglement* of opposing Robots are not part of the ethos of the VEX Robotics Competition and are not allowed.

- VRC Over Under is intended to be an offensive game. Teams that partake in solely defensive or destructive strategies will not have the protections implied by <G13> (see <G14>). However, defensive play which does not involve destructive or illegal strategies is still within the spirit of this rule.
- VRC Over Under is also intended to be an interactive game. Some incidental tipping, *Entanglement*, and damage may occur as a part of normal gameplay without violation. It will be up to the *Head Referee's* discretion whether the interaction was incidental or intentional.
- A Team is responsible for the actions of its Robot at all times, including the *Autonomous Period*. This applies both to Teams that are driving recklessly or potentially causing damage, and to Teams that drive around with a small wheel base. A Team should design its Robot such that it is not easily tipped over or damaged by minor contact.

Violation Notes:

- *Major Violations of this rule are not required to be Match Affecting. Intentional and/or egregious tipping, Entanglement, or damage may be considered a Major Violation at the Head Referee's discretion.*
- *Repeated Violations within a Match or tournament could be considered a Violation of <G1> and/or <S1> at the Head Referee's discretion.*

<G14> Offensive Robots get the "benefit of the doubt." In a case where *Head Referees* are forced to make a judgment call regarding a destructive interaction between a defensive and offensive Robot, or an interaction which results in a questionable *Violation*, referees will err on the side of the offensive Robot.

<G15> You can't force an opponent into a penalty. Intentional strategies that cause an opponent to break a rule are not permitted, and will not result in a *Violation* for the opposing *Alliance*.

Violation Notes: In most cases, if a Team causes their opponent to break a rule, the Head Referee will simply not enforce the penalty on that opponent, and it will be considered a Minor Violation for the guilty Team. However, if the forced situation becomes Match Affecting in favor of the guilty Team, it will be considered a Major Violation.

<G16> No Holding for more than a 5-count. A *Robot* may not *Hold* an opposing *Robot* for more than a 5-count during the *Driver Controlled Period*.

For the purposes of this rule, a "count" is defined as an interval of time that is approximately one second in duration, and "counted-out" by *Head Referees* verbally.

A *Holding* count is over when at least one of the following conditions is met:

- a. The two *Robots* are separated by at least two (2) feet (approximately one foam tile).
- b. Either *Robot* has moved at least two (2) feet away (approximately 1 tile) from the location where the *Trapping* or *Pinning* count began.
 - i. In the case of *Lifting*, this location is measured from where the *Lifted Robot* is released, not from where the *Lifting* began.
- c. The *Holding Robot* becomes *Trapped* or *Pinned* by a different *Robot*.
 - i. In this case, the original count would end, and a new count would begin for the newly Held *Robot*.
- d. In the case of *Trapping*, if an avenue of escape becomes available due to changing circumstances in the *Match*.

After a *Holding* count ends, a *Robot* may not resume *Holding* the same *Robot* again for another 5-count. If a *Team* resumes *Holding* the same *Robot* within that 5-count, the original count will resume from where it ended.

<G17> Use Triballs to play the game. *Triballs* may not be used to accomplish actions that would be otherwise illegal if they were attempted by *Robot* mechanisms (e.g., interfering with an opponent's *Autonomous* routine per <SG9>.)

The intent of this rule is to prohibit *Teams* from using *Triballs* as "gloves" to loophole any rule that states "a *Robot* may not [do some action]". This rule is not intended to be taken in its most extreme literal interpretation, where any interaction between a *Triball* and a *Robot* needs to be scrutinized with the same intensity as if it were a *Robot*.

Violation Notes: If a rule is Violated through the use of Triballs instead of a Robot mechanism, it should be evaluated as though the rule in question had been Violated by a Robot mechanism.

Specific Game Rules

<SG1> **Starting a Match.** Prior to the start of each *Match*, the *Robot* must be placed such that it is:

- a. Contacting at least one (1) of their *Alliance's Starting Tiles*. See Figure 26.
- b. Not contacting any *Starting Tiles* in the same *Offensive Zone* as their *Alliance* partner. One *Robot* must be in the red *Offensive Zone*, and one must be in the blue *Offensive Zone*. See Figure 20.
- c. Not contacting any other gray foam field tiles, including the *Match Load Zones*.
- d. Not contacting any *Triballs* other than a maximum of one (1) *Preload*. See rule <SG4>.
- e. Not contacting any other *Robots*.
- f. Not contacting any *Barriers* or *Elevation Bars*.
 - i. Contact with the field perimeter and/or *Match Load Bars* is permitted, but not required.
- g. Completely stationary (i.e., no motors or other mechanisms are in motion).

Violation Notes: The Match will not begin until the conditions in this rule are met. If a Robot cannot meet these conditions in a timely manner, the Robot will be removed from the field and rules <R3d> and <T5> will apply until the situation is corrected.

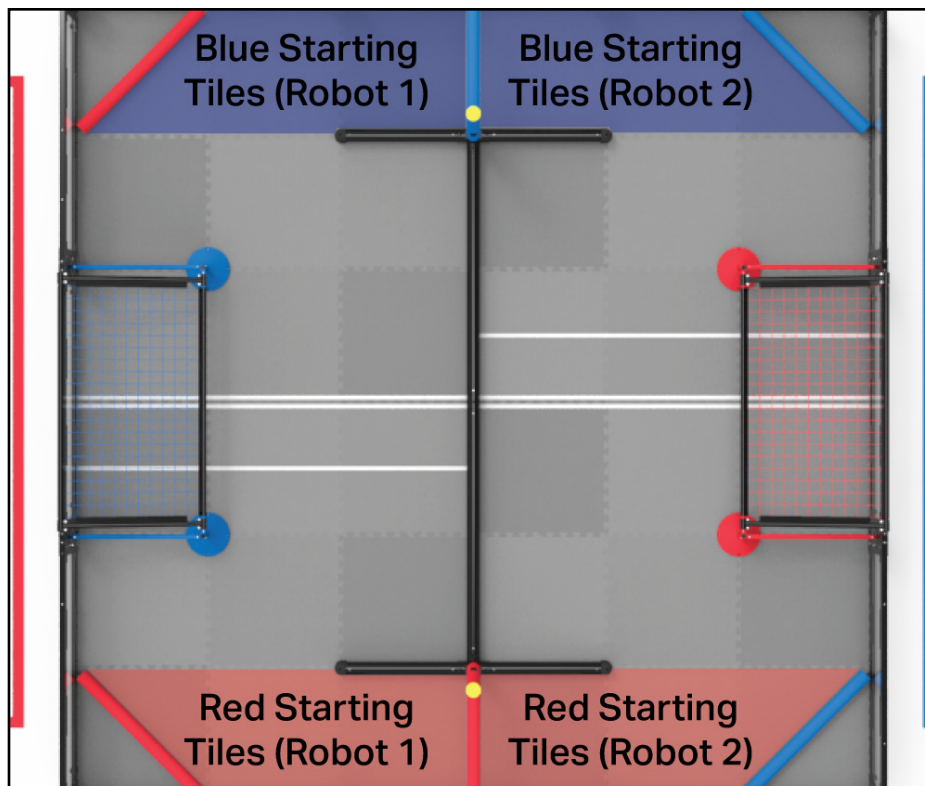

Figure 26: The tiles in which Robots can start a Match.

<SG2> Horizontal expansion is limited. Once the *Match* begins, *Robots* may expand, but no horizontal dimension may exceed 36" (914.4 mm) at any point during the *Match*.

- This limit refers to "horizontal" expansion relative to the playing field (i.e., it does not "rotate with the *Robot*"). For example, *Robots* which tip over during a *Match* or change orientation while *Elevating* are still subject to a 36" horizontal limit.
- There is no height limit on *Robot* expansion.

The following visual references on the field may be used by *Head Referees* when making in-*Match* judgment calls:

- Diagonal of a single field tile (~34")
- Distance from the *Barrier* to the *Neutral Zone's* single white tape line (~34.5")
- Width between *Goal* bases (~39.4")

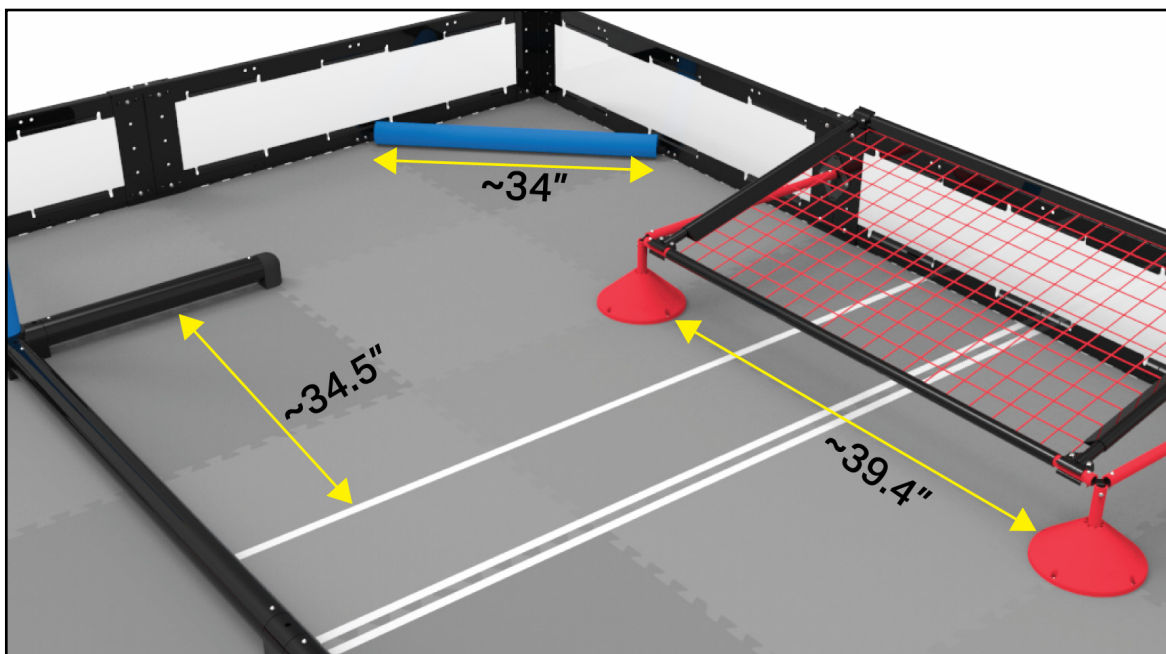

Figure 27: Visual references for a *Head Referee* to determine if a *Robot* has exceeded the maximum expansion limit.

Violation Notes:

- *The primary intent of this rule is to limit defensive horizontal expansion. As such, Robots who choose to expand horizontally in the vicinity of opponent Goals or Match Load Bars may be subject to rule <G14>, and will not receive the "benefit of the doubt" in the case of any Head Referee judgment calls.*
- *Because Elevation is an inherently offensive action, a greater "benefit of the doubt" will be applied to momentary/accidental Minor Violations of this rule during Elevation.*

<SG3> Keep Triballs in the field. Teams may not intentionally remove *Triballs* from the field. Although *Triballs* may accidentally leave the field, doing so intentionally or repeatedly would be a *Violation* of this rule.

Triballs that leave the field during *Match* play, whether intentionally or unintentionally, will be returned to the field at a location nearest the point at which they exited. Referees will return the *Triball* to the field when it is deemed safe to do so, at the leisure of the referee.

Note: Triballs which come to rest on top of a Goal may be retrieved by a Drive Team Member from the Alliance Station adjacent to the Goal in question. The Triball is then considered a Match Load for the Alliance who retrieved the Triball. This momentary interaction is an exception to rule <G9>.

<SG4> Each Robot gets one Alliance Triball as a Preload. Prior to the start of each *Match*, each *Alliance Triball/Preload* that is used must be placed such that it is:

- a. Contacting one *Robot* of the same *Alliance* color as the *Preload*.
- b. Not contacting the same *Robot* as another *Preload*.
- c. Fully within the field perimeter.

If a *Team* does not wish to use their *Preloads*, or if a *Robot* is not present for their *Match*, then the *Preloads* may be used as *Match Load Triballs* in accordance with <SG6>.

Violation Notes: See <SG1>.

<SG5> Stay away from nets on the Goals. Becoming *Entangled* with the net on either *Goal* is considered a violation of <S1> and/or <G7>, and will result in a *Disablement*. Causing an opponent to become *Entangled* with the net is considered a violation of <G15> and, at a minimum, will result in a *Disablement* for both *Teams*.

This rule is a specific exception to <G15>. Normally, under <G15>, a *Robot* which is forced into breaking a rule (such as being pushed into the net) is not penalized. However, because heavy *Robot-to-Robot* interaction is expected around the *Goals*, and *Entanglement* carries a high risk of playing field damage, any *Robot* that becomes *Entangled* must be *Disabled* regardless of fault. *Robots* are responsible for their own actions and mechanism designs.

Note: Directly manipulating the net structure, such as lifting it from the field in an attempt to add or remove Triballs, could be considered a Violation of <SG3>, <G7>, and/or <S2> at the Head Referee's discretion.

Violation Notes:

- *Momentary or incidental contact is expected and is not considered a Violation or Disablement. The rule only becomes invoked once a Robot has become Entangled with a net and the Head Referee wishes to avoid potential field damage.*

- *The Disablement associated with this rule is not considered a Major Violation. It is intended to be an avenue for the Head Referee to prevent any potential safety concerns and/or damage to the net.*
- *Intentional, strategic, or repeated Minor Violations and/or Disablements may escalate to a Major Violation at the Head Referee's discretion.*
- *Disablements last for the remainder of the match, regardless of whether the status that led to Disablement is resolved or not.*

<SG6> Match Load Triballs may be safely introduced during the Match under certain conditions. For the purpose of this rule, "introduce" refers to the moment when a Match Load *Triball* is no longer in contact with a human and has crossed the plane of the field perimeter.

During this action, a *Drive Team Member's* hand may temporarily break the plane of the field perimeter. This momentary interaction is an exception to rule <G9>. Excessive, unnecessary, or unsafe actions while introducing a Match Load may be considered a *Violation* of <S1> and/or <G1> at the *Head Referee's* discretion.

Match Load *Triballs* may be introduced by a *Drive Team Member* in one of two ways:

1. By placing the Match Load gently onto a *Match Load Zone*. This may be done at any time during the *Driver Controlled Period*, provided that no other rules are Violated.
 - a. "Throwing," "rolling," or otherwise imparting enough energy onto a *Triball* such that it bounces out of the *Match Load Zone* is not permitted.
 - b. Note that the *Match Load Zone* refers to the foam tile itself; it is not a three-dimensional volume. There is no rules-bound limit for how many *Triballs* may be in the *Match Load Zone* at any given time, provided that new Match Loads are placed directly onto the foam tile without violating any other rules.
2. By placing the Match Load gently onto a *Robot* from the *Drive Team Member's Alliance*.
 - a. The *Robot* must be contacting the *Match Load Zone* or the *Match Load Bar*.
 - b. Rules <S1> and <S2> still apply to this interaction; there should be no reason for a *Robot* to extend outside of the field perimeter during this action.

Note: Match Load Triballs may only be introduced once the Driver Controlled Period has begun. During the Autonomous Period, and during the time between the Autonomous and Driver Controlled Periods, Match Load Triballs may not cross the plane of the field perimeter.

<SG7> Possession is limited to one (1) Triball. Robots may not have greater-than-momentary Possession of more than one *Triball* at once. Robots in Violation of this rule must immediately stop all *Robot* actions except for attempting to remove the excess *Triball(s)*. This rule applies to both intentional and accidental Possession.

The intent of this rule is not to punish *Robots* for pushing *Triballs* that are in their way; that is, *Robots* are free to incidentally drive through *Triballs* on the field while *Possessing* an *Triball*.

Violation Notes:

- Any intentional Violation by an Alliance who wins the Match will be considered Match Affecting.

Examples of egregious Violations that may immediately escalate to Major Violations include, but are not limited to:

- Continuing to play other portions of the game (e.g., defensive maneuvers, Elevating) without attempting to remove excess Triballs for the majority of the Match
- “Accidentally” Possessing an egregious amount of Triballs

<SG8> Stay out of your opponent’s Goal unless they are Double-Zoned. During the time when an Alliance meets the definition of *Double-Zoning*, opposing *Robots* are permitted to “break the plane” of the *Double-Zoning Alliance’s Goal*, such as to remove *Triballs*.

- This allowance ends once the *Alliance* is no longer *Double-Zoning* (i.e., when one or both of the *Robots* has returned to the other side of the field or contacted the Long Barrier).
- Entering an opponent’s *Goal* at any other time is prohibited. This includes staying inside of an opponent’s *Goal* after they end their *Double-Zone* status.
- This rule applies to both intentional and unintentional interactions. *Teams* are responsible for the actions of their own *Robots*.
- This rule only applies during the *Driver Controlled Period*. Entering an opponent’s *Goal* is not permitted at any time during the *Autonomous Period*.
- If an *Alliance* has only one *Robot* present, then that *Alliance* can never meet the definition of *Double-Zoning*, and therefore its *Goal* is never open for opponent interactions.

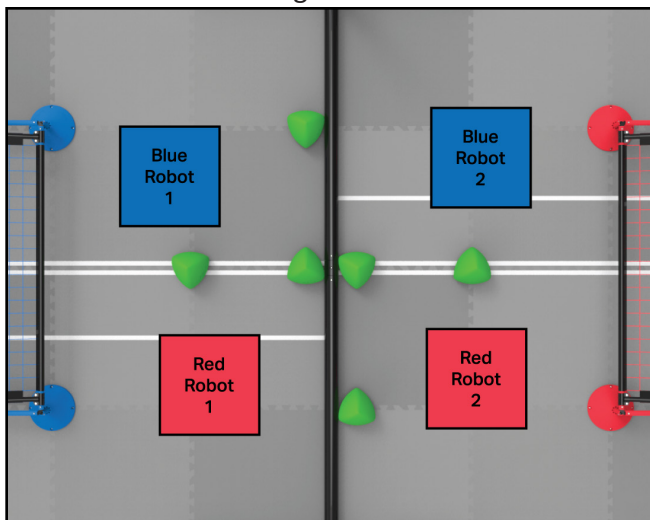

Figure 28: One Robot from each Alliance in their respective Offensive Zones; Triballs in Goals are safe.

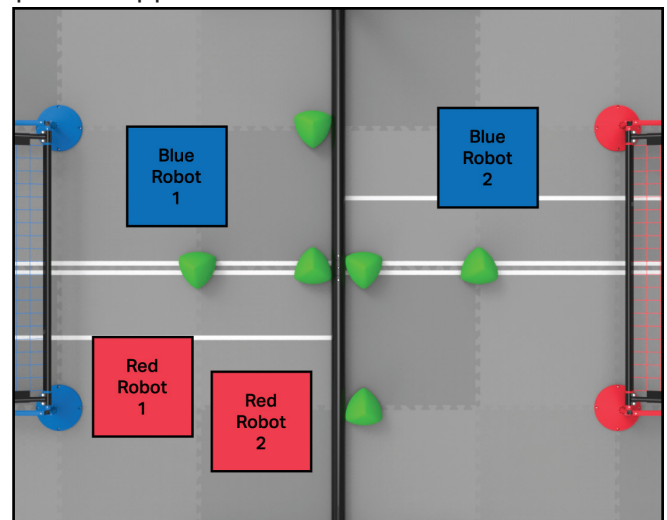

Figure 29: Both Red Robots are in the Blue Offensive Zone; Red Goal is open for de-scoring by a Blue Robot.

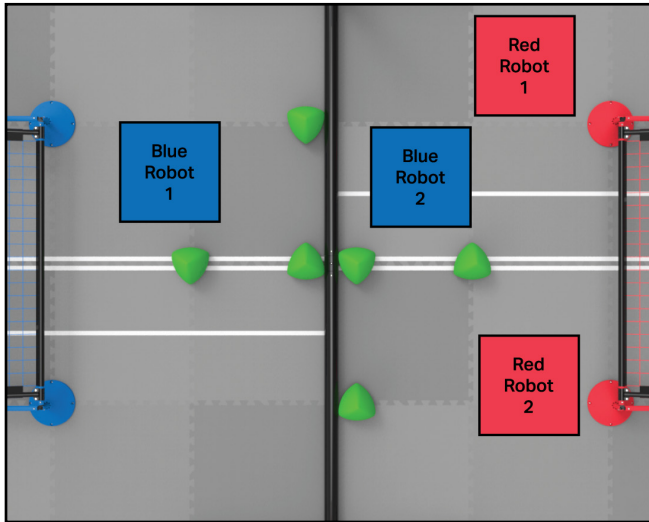

Figure 30: Both Red Robots are in the Red Offensive Zone; Red Goal is open for de-scoring by a Blue Robot.

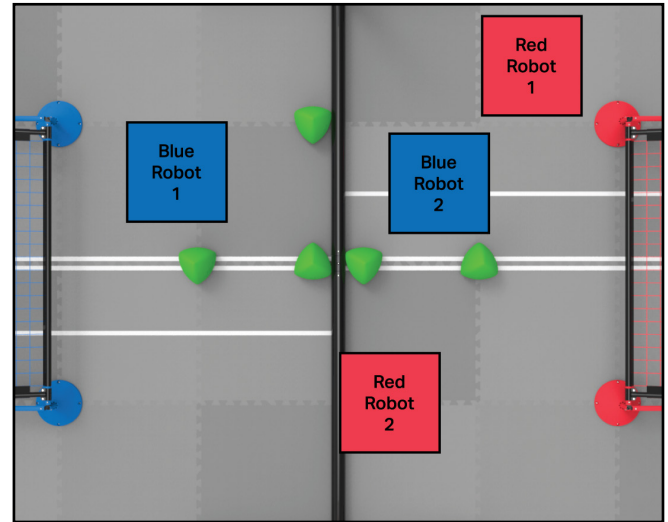

Figure 31: A Red Robot is contacting the Long Barrier; the Red Alliance is NOT Double-Zoning, therefore Triballs in Goals are safe.

Violation Notes: Attempting to remove Triballs from an opponent's Goal is an intentional and inherently defensive action. Therefore, <G14> will apply to these interactions, and the offensive Alliance will always receive the "benefit of the doubt" in the case of any close judgment calls between opposing Robots.

<SG9> Stay in your starting Zone during Autonomous. During the *Autonomous Period*, Robots may not contact foam tiles, *Triballs*, or Field Elements on the opposing *Alliance's* side of the *Neutral Zone*, or in the opposite *Offensive Zone* from which they began the *Match*.

- a. <G17> does not apply to this rule, unless egregiously exploited for strategic gain. It is expected that *Triballs* which are launched as part of normal *Autonomous* gameplay may contact foam tiles on the opponent's side of the field.

Violation Notes:

- *All Violations of this rule (Major or Minor) will result in the Autonomous Bonus being awarded to the opposing Alliance.*
- *Intentional, strategic, or egregious violations, such as intentional contact with an opposing Robot while completely across the Neutral Zone, will be considered Major Violations.*

<SG10> Enter the Neutral Zone during Autonomous at your own risk. Any *Robot* who engages with the *Neutral Zone* during the *Autonomous Period* should be aware that opponent *Robots* may also choose to do the same. Per <G11> and <G12>, *Teams* are responsible for the actions of their *Robots* at all times.

- a. If opposing *Robots* contact one another while both engaging with the *Neutral Zone*, and a possible <G13> violation results (i.e., damage, *Entanglement*, or tipping over), then a judgment call will be made by the *Head Referee* within the context of <G13> and <G14> just as it would if the interaction had occurred during the *Driver Controlled Period*.

- b. In the context of <G14>, the Zones will always determine "offensive"/"defensive" roles during the *Autonomous Period*. For example, in Figure 32, the *Robots* are in the *Blue Offensive Zone*. Therefore, if an interaction occurred in the *Neutral Zone* that required a *Head Referee* judgment call, then *Robot B1* would receive the "benefit of the doubt."

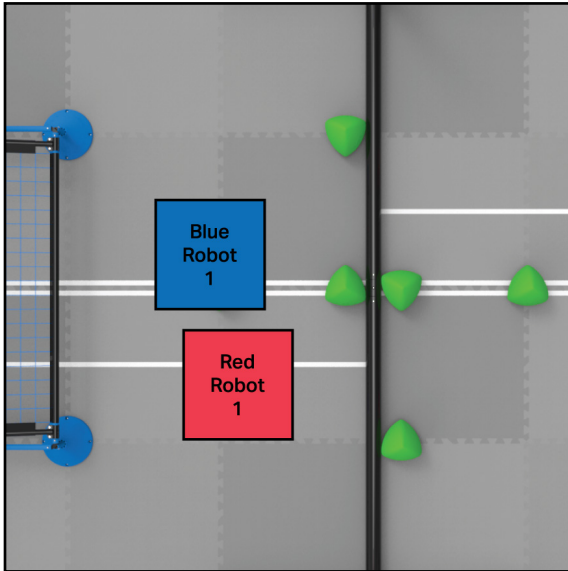

Figure 32: Two Robots legally interacting within the Neutral Zone.

<SG11> Elevated Robots are protected. During the last 30 seconds of the *Match*, *Robots* may not contact the following:

- The opposing *Alliance's Elevation Bars*
- Opponent *Robots* who are contacting their *Elevation Bars*
- Opponent *Robots* who meet the definition of *Elevated*

The intent of this rule is to prevent potentially damaging defensive interactions with *Robots* who are in the process of *Elevating*. Indirect contact may also be considered a *Minor* or *Major Violation* of <G1>, <G13>, or <SG11> at the *Head Referee's* discretion. This could include actions such as:

- Repeatedly hitting the field perimeter wall that the opponent's *Elevation Bar* is connected to
- Repeatedly hitting the *Barrier* adjacent to the opponent's *Elevation Bar*
- Launching *Triballs* at an *Elevated Robots*

Section 3

The Robot

Overview

This section provides rules and requirements for the design and construction of your *Robot*. A VEX Robotics Competition *Robot* is a remotely operated and/or autonomous vehicle designed and built by a registered VEX Robotics Competition *Team* to perform specific tasks.

There are specific rules and limitations that apply to the design and construction of your *Robot*. Please ensure that you are familiar with these *Robot* rules before beginning your *Robot* design. These “inspection rules” are verified prior to the beginning of each event, in a formal *Robot* Inspection.

Inspection Rules are “pass/fail”; there are no Major or *Minor Violations*, only *Violations*. The penalty for all *Violations* is the same, as outlined in <R3d> and <R27>.

Most of these rules are “hard limits,” such as the maximum number of motors permitted. However, some are “at inspector discretion,” such as determining a mechanism’s potential safety risk. At many events, the lead inspector and the *Head Referee* are the same person; if they are not, then the volunteer inspector should confirm any questionable judgment calls with the *Head Referee*. The *Head Referee* has final authority regarding all *Robot* rules, since it is ultimately their decision whether a *Robot* takes the field for a *Match* after inspection has concluded (per <R3d> and <R3e>).

Inspection Rules

<R1> One Robot per Team. Only one (1) *Robot* will be allowed to compete per *Team* at a given event in the VEX Robotics Competition. Though it is expected that *Teams* will make changes to their *Robot* at the competition, a *Team* is limited to only one (1) *Robot* at a given event. A VEX *Robot*, for the purposes of the VEX Robotics Competition, has the following subsystems:

- Subsystem 1: Mobile robotic base including wheels, tracks, legs, or any other mechanism that allows the *Robot* to navigate the majority of the flat playing field surface. For a stationary *Robot*, the robotic base without wheels would be considered Subsystem 1.
- Subsystem 2: Power and control system that includes a legal VEX battery, a legal VEX control system, and associated motors for the mobile robotic base.
- Subsystem 3: Additional mechanisms (and associated motors) that allow manipulation of *Triballs*, Field Elements, or navigation of field obstacles.

Given the above definitions, a minimum *Robot* for use in any VEX Robotics Competition event (including Skills Challenges) must consist of subsystems 1 and 2 above. Thus, if you are swapping out an entire subsystem 1 or 2, you have now created a second *Robot* and have *Violated* this rule.

- a. *Teams* may not compete with one *Robot* while a second is being modified or assembled at a competition.

- b. *Teams* may not have an assembled second *Robot* on-hand at a competition that is used to repair or swap parts with the first *Robot*.
- c. *Teams* may not switch back and forth between multiple *Robots* during a competition. This includes using different *Robots* for *Skills Challenges*, *Qualification Matches* and/or *Elimination Matches*.
- d. Multiple *Teams* may not use the same *Robot*. Once a *Robot* has competed under a given *Team* number at an event, it is “their” *Robot*; no other *Teams* may compete with it for the duration of the competition season.

The intent of <R1a>, <R1b>, and <R1c> is to ensure an unambiguous level playing field for all *Teams*. *Teams* are welcome (and encouraged) to improve or modify their *Robots* between events, or to collaborate with other *Teams* to develop the best possible game solution.

However, a *Team* who brings and/or competes with two separate *Robots* at the same tournament has diminished the efforts of a *Team* who spent extra design time making sure that their one *Robot* can accomplish all of the game’s tasks. A multi-*Team* organization that shares a single *Robot* has diminished the efforts of a multi-*Team* organization who puts in the time, effort, and resources to undergo separate individual design processes and develop their own *Robots*.

To help determine if a *Robot* is a “separate *Robot*” or not, use the subsystem definitions found in <R1>. Above that, use common sense as referenced in <G3>. If you can place two *Robots* on a table next to each other, and they look like two separate legal/complete *Robots* (i.e., each has the 3 subsystems defined by <R1>), then they are two *Robots*. Trying to decide if changing a screw, a wheel, or a microcontroller constitutes a separate *Robot* is missing the intent and spirit of this rule.

<R2> Robots must represent the Team’s skill level. The *Robot* must be designed, built, and programmed by members of the *Team*. *Adults* are expected to mentor and teach design, building, and Programming Skills to the *Students* on the *Team*, but may not design, build, or program that *Team’s Robot*. See rules <G2> and <G4>.

In VRC, we expect *Adults* to teach fundamental *Robot* principles like linkages, drive-trains, and manipulators, then allow the *Students* to determine which designs to implement and build on their *Robot*.

Similarly, *Adults* are encouraged to teach the *Students* how to code various functions involving applicable sensors and mechanisms, then have the *Students* program the *Robot* from what they have learned.

<R3> Robots must pass inspection. Every *Robot* will be required to pass a full inspection before being cleared to compete. This inspection will ensure that all *Robot* rules and regulations are met. Initial inspections will take place during team registration/practice time. Noncompliance with any *Robot* design or construction rule will result in removal from *Matches* or *Disqualification* of the *Robot* at an event until the *Robot* is brought back into compliance, as described in the following subclauses.

- a. Significant changes to a *Robot*, such as a partial or full swap of Subsystem 3, must be re-inspected before the *Robot* may compete again.
- b. All possible functional *Robot* configurations must be inspected before being used in competition. This especially pertains to modular or swappable mechanisms (per <R1>) and *Match* starting configurations/sizes (per <R4>).
- c. *Teams* may be requested to submit to random spot inspections by *Head Referees*. Refusal to submit will result in *Disqualification*.
 - i. If a *Robot* is determined to be in *Violation* of a *Robot* rule before a *Match* begins, the *Robot* will be removed from the field. A *Drive Team Member* may remain at the field so that the *Team* does not get assessed a "no-show" (per <T5>).
- d. *Robots* which have not passed inspection (i.e., that may be in *Violation* of one or more *Robot* rules) will not be permitted to play in any *Matches* until they have done so. <T5> will apply to any *Matches* that occur until the *Robot* has passed inspection.
- e. If a *Robot* has passed inspection, but is later confirmed to be in *Violation* of a *Robot* rule during or immediately following a *Match* by a *Head Referee*, they will be *Disqualified* from that *Match*. This is the only *Match* that will be affected; any prior *Matches* that have already been completed will not be revisited. <R3d> will apply until the *Violation* is remedied and the *Team* is re-inspected.
- f. All Inspection Rules are to be enforced within the discretion of the *Head Referee* within a given event. *Robot* legality at one event does not automatically imply legality at future events. *Robots* which rely on "edge-case" interpretations of subjective rules, such as whether a decoration is "non-functional" or not, should expect additional scrutiny during inspection.

<R4> Robots must fit within an 18" x 18" x 18" volume.

- a. Compliance with this rule must be checked using the official VEX Robotics On-Field Robot Expansion Sizing Tool: <https://www.vexrobotics.com/276-5942.html>.
- b. Any restraints used to maintain starting size (i.e., zip ties, rubber bands, etc.) must remain attached to the *Robot* for the duration of the *Match*, per <G6>.
- c. For the purposes of this rule, it can be assumed that *Robots* will be inspected and begin each *Match* on a flat standard foam field tile.

The official sizing tool is intentionally manufactured with a slightly oversized tolerance. Therefore, any contact with the sizing tool (i.e., a "paper test") while being measured should be considered a clear indication that a *Robot* is outside of the permitted size. This tolerance also provides a slight "leeway" for minor protrusions, such as screw heads or zip ties.

Other tools, such as custom sizing boxes or the legacy non-expanding VEX Sizing Tool (276-2086), may be used for informal checks. However, in the event of a conflict or “close call,” a check with the official On-Field Robot Expansion Sizing Tool takes precedence.

Although it is not required by <R4>, events may also choose to check that any possible *Robot* expansion satisfies the requirements of <SG2> during inspection. The intent of this check is to help *Teams* identify any potential *Violation* risks before their *Matches*.

<R5> Robots must be safe. The following types of mechanisms and components are NOT allowed:

- a. Those that could potentially damage Field Elements or *Triballs*.
- b. Those that could potentially damage other competing *Robots*.
- c. Those that pose an unnecessary risk of *Entanglement* with other *Robots* or a net.
- d. Those that could pose a potential safety hazard to *Drive Team Members*, event staff, or other humans.

<R6> Robots are built from the VEX V5 system. *Robots* may be built ONLY using official VEX V5 components, unless otherwise specifically noted within these rules. *Teams* are responsible for providing documentation proving a part’s legality in the event of a question. Examples of documentation include receipts, part numbers, official VEX websites, or other printed evidence.

- a. Products from the VEXpro, VEX EXP, VEX IQ, VEX GO, VEX 123, or VEX Robotics by HEXBUG* product lines cannot be used for *Robot* construction, unless specifically allowed by a clause of <R7> or “cross-listed” as part of the VEX V5 Product lines. For example, Flex Wheels and Versa-Hubs are VEXpro components that can be found on the VEX “Flex Wheels” page, and are thus legal: <https://www.vexrobotics.com/vrc-flex-wheels.html>.

* The HEXBUG brand is a registered trademark belonging to Spin Master Corp

- b. The following electronics from the VEX Cortex control system are not permitted.

SKU	Description
276-2192	VEXnet Joystick
276-1891	VEXnet Partner Joystick
276-2194	VEX ARM® Cortex-based Microcontroller
276-2245 / 276-3245	VEXnet Key 1.0 / 2.0
276-2177	2-Wire Motor 393
276-2162	3-Wire Servo
276-2210	VEX Flashlight
276-2193	Motor Controller 29

- c. The following electronics from the VEX Cortex control system are permitted.

SKU	Description
276-2174 / 276-4859	Limit Switch V1 / V2
276-2159	Bumper Switch
276-2156	Optical Shaft Encoder
276-2216	Potentiometer
276-2155	Ultrasonic Range Finder
276-2176	LED Indicator
276-2333	Yaw Rate Gyroscope
276-2332	Analog Accelerometer V1.0
276-2154	Line Tracker
276-1380	Jumper
276-2158	Light Sensor

- d. Components that are unique to the V5 Workcell product line are not permitted. This includes the following.

SKU	Description
276-7151	Robot Arm Metal
276-7152	Robot Brain Mount
276-7153	Input Output Conveyor
276-7720	Disc Feeder
276-7047	V5 Electromagnet

- e. VEX IQ pins are permitted.
- f. Components obtained from the V5 beta program, including V5 beta firmware, are not legal for competition use.
- i. All V5 beta hardware can be identified by its lighter gray pre-production color. Robot Brains, Robot Batteries, Controllers, and Vision Sensors from the V5 beta have a "BETA TEST" stamp on them. Smart Motors and Radios do not have this stamp, but can still be identified by color.
- g. Components from the VEXplorer kit that are not found in modern VEX V5 kits are not permitted. These include (but may not be limited to) electronics, wheels, non-standard gears, and plastic connectors.
- h. Official VEX products are ONLY available from VEX Robotics. All official products are listed on www.vexrobotics.com.

Using VEX apparel, competition support materials, packaging, or other non-*Robot* products on a VEX Robotics Competition *Robot* goes against the spirit of this rule and is not permitted.

<R7> Certain non-VEX components are allowed. *Robots* are allowed the following additional “non-VEX” components:

- a. Any material strictly used as a color filter or a color marker for a legal sensor, such as the VEX Light Sensor or the VEX V5 Vision Sensor.
- b. Any non-aerosol-based grease or lubricating compound, when used in extreme moderation on surfaces and locations that do NOT contact the playing field walls, foam field surface, *Triballs*, or other *Robots*.
- c. Anti-static compound, when used in extreme moderation (i.e., such that it does not leave residue on Field Elements, *Triballs*, or other *Robots*).
- d. Hot glue when used to secure cable connections.
- e. An unlimited amount of rope / string, no thicker than 1/4” (6.35mm).
- f. Commercially available items used solely for bundling or wrapping of 2-wire, 3-wire, 4-wire, or V5 Smart Cables, and/or pneumatic tubing are allowed. These items must solely be used for the purposes of cable/tubing protection, organization, or management. This includes but is not limited to electrical tape, cable carrier, cable track, etc. It is up to inspectors to determine whether a component is serving a function beyond protecting and managing cables and tubing.
- g. Non-functional 3D printed license plates, per <R8> and <R9>, are permitted. This includes any supporting structures whose sole purpose is to hold, mount, or display an official license plate.
- h. Rubber bands that are identical in length and thickness to those included in the VEX V5 product line (#32, #64 and 117B).
- i. Pneumatic components with identical SMC manufacturer part numbers to those listed on the VEX website. For more detail regarding legal pneumatic components, see the Legal VEX Pneumatics Summary document: <https://link.vex.com/docs/2022-2023/vrc-spin-up/LegalPneumatics>.
- j. Zip ties that are identical in length and thickness to those included in the VEX V5 product line (4” or 11” long).

<R8> Decorations are allowed. *Teams* may add non-functional decorations, provided that they do not affect *Robot* performance in any significant way or affect the outcome of the *Match*. These decorations must be in the spirit of the competition. Inspectors will have final say in what is considered “non-functional.” Unless otherwise specified below, non-functional decorations are governed by all standard *Robot* rules.

To be considered “non-functional,” any guards, decals, or other decorations must be backed by legal materials that provide the same functionality. For example, if a *Robot* has a giant decal that prevents *Triballs* from falling out of the *Robot*, the decal must be backed by VEX material that would also prevent the *Triballs* from falling out. A simple way to check this is to determine if removing the decoration would impact the performance of the *Robot* in any way.

- a. Anodizing and painting of parts is considered a legal nonfunctional decoration.

- b. Small cameras are permitted as non-functional decorations, provided that any transmitting functions or wireless communications are disabled. Unusually large cameras being used as ballast are not permitted.
- c. VEX electronics may not be used as non-functional decorations.
- d. Decorations that visually mimic Field Elements, or could otherwise interfere with an opponent's Vision Sensor, are considered functional and are not permitted. The Inspector and *Head Referee* will make the final decision on whether a given decoration or mechanism violates this rule.
- e. Internal power sources (e.g., for a small blinking light) are permitted, provided that no other rules are violated and this source only provides power to the non-functional decoration (i.e., does not directly or indirectly influence any functional portions of the *Robot*).
- f. Decorations which provide feedback to the *Robot* (e.g., by influencing legal sensors) would be considered "functional," and are not permitted.
- g. Decorations which provide visual feedback to *Drive Team Members* (e.g., decorative lighting) are permitted, provided that they do not violate any other rules and serve no other function (e.g., structural support).

<R9> Officially registered Team numbers must be displayed on Robot License Plates. To participate in an official VEX Robotics Competition event, a *Team* must first register on robotevents.com and receive a VRC Team number. This *Team* number must be displayed on a minimum of two (2) sides of the *Robot* using *License Plates*. *Teams* may choose to use the official VRC License Plate Kit, or may create their own.

- a. *Robots* must use plates that match their *Alliance* color for each *Match* (i.e., red *Alliance Robots* must have their red plates on for the *Match*). It must be abundantly clear which color *Alliance* the *Robot* belongs to.
 - i. If both colors of *License Plates* are mounted on a *Robot*, then the incorrect color must be covered, taped over, or otherwise obscured. Since *License Plates* are considered non-functional decorations, this is a legal non-functional use of tape.
- b. *License Plates* are considered non-functional decorations (per <R8>), and must fulfill all relevant *Robot* rules (e.g., they must fit within the 18" cube, cannot functionally change the stability or rigidity of the *Robot*, cause *Entanglement*, etc.)
- c. *Team* numbers must be in white font, and clearly legible.
- d. *License Plates* must be at least 2.48 inches (63.2mm) tall and 4.48 inches (114mm) wide, i.e., at least the height/width dimensions of the plates in the VRC License Plate Kit.

The intent of this rule is to make it immediately apparent to *Head Referees* which *Alliance* and which *Team* each *Robot* belongs to, at all times. Being able to "see through" a *Robot* arm to the wrong color *License Plate* on the opposite side of the *Robot* could cause confusion, and would be considered a violation of <R8a>.

It will be at the full discretion of the *Head Referee* and inspector at a given event to determine whether a given custom *License Plate* satisfies the criteria listed in <R8>.

Teams wishing to utilize custom plates should be prepared for the possibility of this judgment, and ensure that they are prepared to replace any custom parts with official VEX License Plates if requested. Not bringing official replacement plates to an event will not be an acceptable reason for overlooking a violation of one or more points in <R8>.

If a Robot must be removed from the Field based on this rule, <R3ci> applies and the Team should not be issued a "no-show."



Figure 33: An example of a License Plate made from the VRC License Plate Kit



Figure 34: An example of a legal custom License Plate

<R10> Let go of Triballs after the Match. Robots must be designed to permit easy removal of Triballs from any mechanism without requiring the Robot to have power after a Match.

<R11> Robots have one microcontroller. Robots must ONLY use one (1) VEX V5 Robot Brain (276-4810). Any other microcontrollers or processing devices are not allowed, even as non-functional decorations.

This includes microcontrollers that are part of other VEX product lines, such as VEX Cortex, VEX EXP, VEXpro, VEX RCR, VEX IQ, VEX GO, or VEX Robotics by HEXBUG. This also includes devices that are unrelated to VEX, such as Raspberry Pi or Arduino devices.

<R12> Motors are limited. Robots may use any combination of VEX V5 Smart Motors (11W) (276-4840) and V5 Smart Motors (5.5W) (276-4842), within the following criteria:

- a. The combined power of all motors (11W & 5.5W) must not exceed 88W.
- b. V5 Smart Motors, connected to Smart Ports, are the only motors that may be used with a V5 Robot Brain. The 3-wire ports may not be used to control motors of any kind.

Examples of legal motor combinations:

Example	A	B	C	D	E
Qty of 11W Motors:	8	7	6	5	0
Qty of 5.5W Motors:	0	2	4	6	16

<R13> Electrical power comes from VEX batteries only. Robots may use one (1) V5 Robot Battery (276-4811) to power the V5 Robot Brain.

- a. No other sources of electrical power are permitted, unless used as part of a non-functional decoration per <R8e>.
- b. There are no legal power expanders for the V5 Robot Battery.
- c. V5 Robot Batteries may only be charged by a V5 Robot Battery Charger (276-4812 or 276-4841).
- d. V5 Wireless Controllers may only be powered by their internal rechargeable battery.
 - i. *Teams* are permitted to have an external power source (such as a rechargeable battery pack) plugged into their V5 Controller during a *Match*, provided that this power source is connected safely and does not violate any other rules, such as <G10> or <R15>.
 - ii. Some events may choose to provide field power for V5 Wireless Controllers. If this is provided for all *Teams* at the event, then this is a legal power source for the wireless remotes.

<R14> No modifications to electronic or pneumatic components are allowed. Motors (including the internal PTC or V5 Smart Motor firmware), microcontrollers (including V5 Robot Brain firmware), cables, sensors, controllers, battery packs, reservoirs, solenoids, pneumatic cylinders, and any other electrical or pneumatics component of the VEX platform may NOT be altered from their original state in ANY way.

- a. External wires on VEX 2-wire or 3-wire electrical components may be repaired by soldering or using twist/crimp connectors, electrical tape, or shrink tubing such that the original functionality and length are not modified in any way.
 - i. Wire used in repairs must be identical to VEX wire.
 - ii. *Teams* make these repairs at their own risk; incorrect wiring may have undesired results.
- b. *Teams* must use the latest official VEXos firmware updates, found at <https://link.vex.com/firmware>. Custom firmware modifications are not permitted.
- c. *Teams* may make the following modifications to the V5 Smart Motor's user-serviceable features. This list is all-inclusive; no other modifications are permitted. Where applicable, the components listed below (in the specific applications listed below) are permissible exceptions to <R20>.
 - i. Replacing the gear cartridge with other official cartridges.
 - ii. Removing or replacing the screws from the V5 Smart Motor Cap (276-6780).
 - iii. Removing or replacing the threaded mounting inserts (276-6781).
 - iv. Aesthetic/non-functional labeling (e.g., markers, stickers, paint, etc.).
- d. V5 Smart Motors (11W) **must** use an official VEX V5 gear cartridge. For the purposes of this rule, the gear cartridges found within the V5 Smart Motor are considered "part of the motor." Therefore, any physical or functional modifications to official gear cartridges is not permitted. 11w V5 Smart Motors may only use official VEX motor cartridges

- e. For the purposes of this rule, the V5 Smart Motor Cap is not considered “part of the motor.” Therefore, <R15> applies.

<R15> Most modifications to non-electrical components are allowed. Physical modifications, such as bending or cutting, of legal metal structure or plastic components are permitted.

- a. Internal or external mechanical repairs of VEX Limit and Bumper switches are permitted.
 - i. Modifying the metal arm on the Limit Switch is permitted.
 - ii. Using components from these devices in other applications is prohibited.
- b. Metallurgical modifications that change fundamental material properties, such as heat treating or melting, are not permitted.
- c. Pneumatic tubing may be cut to desired lengths.
- d. Fusing/melting the end of legal nylon rope/string (see <R7e>) to prevent fraying is permitted.
- e. Welding, soldering, brazing, gluing, or attaching parts to each other in any way that is not provided within the VEX platform is not permitted.
- f. Mechanical fasteners may be secured using Loctite or a similar thread-locking product. This may ONLY be used for securing hardware, such as screws and nuts.

<R16> Robots use VEXnet. Robots must ONLY utilize the VEXnet system for all wireless *Robot* communication.

- a. Electronics from the Cortex, VEX EXP, VEXpro, VEX RCR, VEXplorer, VEX IQ, VEX GO, or VEX Robotics by HEXBUG product line are prohibited unless otherwise noted in <R6c>.
- b. V5 Controllers may only be used in conjunction with a V5 Robot Brain.
- c. *Teams* are permitted to use the Bluetooth® capabilities of the V5 Robot Brain and/or V5 Controller in *Team* pits or outside of *Matches*. However, VEXnet must be used for wireless communication during *Matches*.
- d. *Teams* are permitted to use the Wi-Fi capabilities of the Vision Sensor in *Team* pits or outside of *Matches*. However, the Vision Sensor must have its wireless transmitting functionality disabled during *Matches*.

<R17> Give the radio some space. The V5 Radio must be mounted such that no metal surrounds the radio symbol on the V5 Radio.

It is fine to loosely encapsulate the V5 Radio within *Robot* structure. The intent of this rule is to minimize radio connection issues by minimizing obstructions between VEXnet devices. Burying a radio deep within a *Robot* may result in *Robot* communication issues.

<R18> A limited amount of custom plastic is allowed. Robots may use custom-made parts cut from certain types of non-shattering plastic. It must be possible to have cut all of the plastic parts on the Robot from a single 12" x 24" sheet, up to 0.070" thick.

- a. The intent of the area/thickness constraints is to limit the number of custom plastic parts used in Robot construction, not to define an absolute volume. For example, using a sheet which is 0.035" thick does not permit two 12" x 24" sheets' worth of parts.
- b. Plastic parts do not have to be literally cut from the same original 12" x 24" sheet. However, all individual parts must be able to "nest" or rearrange into a 12" x 24" area.
 - i. A collection of parts which theoretically have a total surface area of 288 in², but cannot be nested onto a single 12" x 24" sheet, would not be legal. See Figure 35.
- c. Plastic may be mechanically altered by cutting, drilling, bending, etc. It cannot be chemically treated, melted, or cast. Heating polycarbonate to aid in bending is acceptable.
- d. Legal plastic types include polycarbonate (Lexan), acetal monopolymer (Delrin), acetal copolymer (Acetron GP), POM (acetal), ABS, PEEK, PET, HDPE, LDPE, Nylon (all grades), Polypropylene, and FEP.
- e. Shattering plastic, such as PMMA (also called Plexiglass, Acrylic, or Perspex), is prohibited.
- f. The PET Sheet Variety Pack (276-8340), sold by VEX, is considered "plastic" in the context of this rule, and is subject to the same limitations as "off-the-shelf" plastic sheets.
- g. This rule does not apply to 3D printed plastic parts. 3D printed parts are not permitted in the VEX Robotics Competition, except as non-functional decorations (per <R8>) or as custom *License Plates* (per <R9>).

Note: The phrase "as cut from a single 12" x 24" sheet" is intended to mean that all individual plastic pieces must be able to theoretically "nest" or rearrange into a 12" x 24" area. The plastic pieces do not have to be cut from the same original 12" x 24" sheet. Teams are encouraged to "map" plastic use on a 12"x24" sheet of paper for reference at tournament inspection.

<R19> A limited amount of tape is allowed. Robots may use a small amount of tape for the following purposes:

- a. To secure any connection between the ends of two (2) VEX cables.
- b. To label wires and motors.
- c. To cover the backs of license plates (i.e., hiding the "wrong color").
- d. To prevent leaks on the threaded portions of pneumatic fittings. This is the only acceptable use of Teflon tape.
- e. In any other application that would be considered a "non-functional decoration" per <R8>.

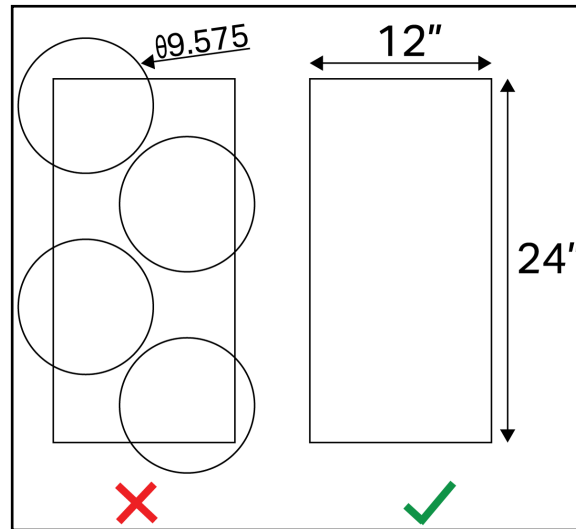

Figure 35: Custom plastic parts must fit within a single 12" x 24" sheet of plastic.

<R20> Certain non-VEX fasteners are allowed. Robots may use the following commercially available hardware:

- #4, #6, #8, M3, M3.5, or M4 screws up to 2.5" (63.5mm) long.
- Shoulder screws cannot have a shoulder length over 0.20" or a diameter over 0.176".
- Any commercially available nut, washer, standoff, and/or non-threaded spacer up to 2.5" (63.5mm) long which fits these screws.

The intent of the rule is to allow *Teams* to purchase their own commodity hardware without introducing additional functionality not found in standard VEX equipment. It is up to inspectors to determine whether the non-VEX hardware has introduced additional functionality or not.

For the purposes of this rule, weight savings is not considered additional functionality.

If a key component of a *Robot's* design relies upon convincing an inspector that a specialized component is "technically a screw," it is probably outside of the spirit and intent of this rule.

All specific dimensions listed in this rule are intended to be 'nominal' references to hardware sizes found within the VEX V5 product line and/or their metric equivalents.

<R21> New VEX parts are legal. Additional VEX components released during the competition season on www.vexrobotics.com are considered legal for use unless otherwise noted.

Some "new" components may have certain restrictions placed on them upon their release. These restrictions will be documented in the official Q&A, in a Game Manual Update, or on their respective product web pages.

<R22> Pneumatics are limited. A *Robot's* pneumatic subsystem must satisfy the following criteria:

- a. *Teams* may use a maximum of two (2) legal VEX pneumatic air reservoirs on a *Robot*.
- b. Pneumatic devices may be charged to a maximum of 100 psi.
- c. The compressed air contained inside a pneumatic subsystem can only be used to actuate legal pneumatic devices (e.g., cylinders).

The intent of <R22a> and <R22b> is to limit *Robots* to the air pressure stored in two reservoir tanks, as well as the normal working air pressure contained in their pneumatic cylinders and tubing on the *Robot*. *Teams* may not use other elements for the purposes of storing or generating air pressure. Using cylinders or additional pneumatic tubing solely for additional storage is in *Violation* of the spirit of this rule.

Using cylinders or additional pneumatic tubing solely for additional storage is in *Violation* of the spirit of this rule. Similarly, using pneumatic cylinders and/or tubing without any air reservoirs is also in *Violation* of the spirit of this rule.

The intent of <R22c> is to ensure that pneumatics are being used safely. Pressurized systems, such as a *Robot's* pneumatic subsystem, have the potential to be dangerous if used incorrectly. This rule ensures the safety of participants, and prevents potentially unsafe uses in the future.

Another way of thinking of <R22c> is that pneumatics should only be used with pneumatics. *Teams* should not use compressed air as a means of actuating non-pneumatic devices such as screws, nuts, etc. For example, pulling a pin with a pneumatic cylinder is okay, but using air to actuate the pin itself is not.

<R23> One or two Controllers per Robot. No more than two (2) VEX V5 Controllers may control a single *Robot*.

- a. No physical or electrical modification of these Controllers are allowed under any circumstances.
 - i. Attachments which assist the *Drive Team Member* in holding or manipulating buttons/joy-sticks on the V5 Controller are permitted, provided that they do not involve direct physical or electrical modification of the Controller itself.
- b. No other methods of controlling the *Robot* (light, sound, etc.) are permissible.
 - i. Using sensor feedback to augment driver control (such as motor encoders or the Vision Sensor) is permitted.

<R24> Custom V5 Smart Cables are allowed. *Teams* who create custom cables acknowledge that incorrect wiring may have undesired results.

- a. Official V5 Smart Cable Stock must be used.
- b. Use of non-VEX 4P4C connectors and 4P4C crimping tools is permissible.
- c. V5 Smart Cables may only be used for connecting legal electronic devices to the V5 Robot Brain.

<R25> Keep the power button accessible. The on/off button on the V5 Robot Brain must be accessible without moving or lifting the *Robot*. All screens and/or lights must also be easily visible by competition personnel to assist in diagnosing *Robot* problems.

<R26> Use a "Competition Template" for programming. The *Robot* must be programmed to follow control directions provided by the VEXnet Field Controllers or Smart Field Control system.

During the *Autonomous Period*, *Drive Team Members* will not be allowed to use their V5 Controllers. As such, *Teams* are responsible for programming their *Robot* with custom software if they want to perform in the *Autonomous Period*. *Robots* must be programmed to follow control directions provided by the field controls (i.e., ignore wireless input during the *Autonomous Period*, disable at the end of the *Driver Controlled Period*, etc.).

Teams must use a provided "competition template" or functional equivalent to accomplish this. This will be tested in inspection, where *Robots* will be required to pass a functional "enable/disable" test. For more information on this, *Teams* should consult the help guides produced by the developers of their chosen programming software.

<R27> There is a difference between accidentally and willfully violating a Robot rule. Any violation of *Robot* rules, accidental or intentional, will result in a *Team* being unable to play until they pass inspection (per <R3d>).

However, *Teams* who intentionally and/or knowingly circumvent or violate rules to gain an advantage over their fellow competitors are in violation of the spirit and ethos of the competition. Any *Violation* of this sort may be considered a violation of <G1> and/or the REC Foundation Code of Conduct.

Section 4

The Tournament

Overview

VEX Robotics Competition *Matches* are played in a Head-to-Head tournament format. Head-to-Head Tournaments consist of *Qualification Matches* and *Elimination Matches*. *Qualification Matches* are used to rank *Teams* based on *Win Points* (WP), *Autonomous Points* (AP), and *Strength of Schedule Points* (SP). The top-ranked *Teams* will then form *Alliances* to participate in *Elimination Matches* and determine the tournament champions. For information about the requirements for tournaments that qualify teams to championship events, [visit this article in the REC Library](#).

This section refers primarily to Head-to-Head *Matches*. For other types of *Matches*, see Appendices B & C.

Tournament Definitions

Alliance Captain – One of the *Teams* with the privilege of inviting another available *Team* to form an *Alliance* for the *Elimination Matches*. See <T18>.

Alliance Selection – The process of choosing the permanent *Alliances* for the *Elimination Matches*. *Alliance Selection* proceeds as follows:

1. The highest-ranked *Team* at the end of *Qualification Matches* becomes the first *Alliance Captain*.
2. The *Alliance Captain* invites another *Team* to join their *Alliance*.
3. The invited *Team Representative* either accepts or declines as outlined in <T18>.
4. The next-highest-ranked *Team* becomes the next *Alliance Captain*.
5. *Alliance Captains* continue to select their *Alliances* in this order until all *Alliances* are formed for the *Elimination Matches*.

Autonomous Points (AP) – The second basis of ranking *Teams*. An *Alliance* who wins the *Autonomous Bonus* during a *Qualification Match* earns eight (8) *Autonomous Points*. In the event of a tie, both *Alliances* will receive four (4) *Autonomous Points*.

Autonomous Win Point – One (1) *Win Point* (WP) given to an *Alliance* that completes the tasks described in <SC7>, by the end of the *Autonomous Period*. Both *Alliances* can earn this WP if both *Alliances* accomplish this task.

Bye – An *Elimination Match* in which an *Alliance* automatically advances to the next round of tournament play without competing.

Elimination Bracket – A schedule of *Elimination Matches* for eight (8) to sixteen (16) *Alliances*. See <T19>.

Elimination Match – A *Match* used in the process of determining the champion *Alliance*. *Alliances* of two (2) *Teams* face off according to the *Elimination Bracket*; the winning *Alliance* moves on to the next round.

Event Partner – The volunteer VEX Robotics Competition tournament coordinator who serves as an overall manager for the volunteers, venue, event materials, and all other event considerations. *Event Partners* serve as the official liaison between the REC Foundation, the event volunteers, and event attendees.

Head Referee – A certified impartial volunteer responsible for enforcing the rules in this manual as written. *Head Referees* are the only individuals who may discuss ruling interpretations or scoring questions with *Teams* at an event. Large events (e.g., Signature Events, World Championships, etc.) might include multiple *Head Referees* at the *Event Partner's* discretion.

Match Schedule – A list of *Matches* that is generated at the start of an event. The *Match Schedule* includes the predetermined, randomly-paired *Alliances* that will be competing in each *Qualification Match*, and the expected start times for these *Matches*. The *Match Schedule* may be subject to change at the *Event Partner's* discretion.

Qualification Match List KALAHARI CLASSIC INDOOR WATERPARK VEX VRC High School Signature Event - Zambezi						
Match	Field	Time	Red 1	Red 2	Blue 1	Blue 2
Q1	Field 1	Fri 9:00 AM	3547Y	7316G	248E	99999V
Q2	Field 1	Fri 9:06 AM	3145M	26681B	8823G	23017A
Q3	Field 1	Fri 9:12 AM	59759A	45224A	6008B	2011G
Q4	Field 1	Fri 9:18 AM	75476Z	7882F	11124E	169A
Q5	Field 1	Fri 9:24 AM	7882B	9364C	40938A	1375A
Q6	Field 1	Fri 9:30 AM	7316A	98575A	6210Y	6741A
Q7	Field 1	Fri 9:36 AM	97031A	6008Z	6741E	7316X
Q8	Field 1	Fri 9:42 AM	2894B	5430A	1274A	3547A
Q9	Field 1	Fri 9:48 AM	11254X	60883D	23017C	2719J
Q10	Field 1	Fri 9:54 AM	323V	9364E	2011A	81P
Q11	Field 1	Fri 10:00 AM	6842C	2719A	6302U	248C
Q12	Field 1	Fri 10:06 AM	11124W	6403W	9364A	9257C
Q13	Field 1	Fri 10:12 AM	2011C	6008N	244D	44691X
Q14	Field 1	Fri 10:18 AM	60470S	8823C	8823E	11124P
Q15	Field 1	Fri 10:24 AM	7316E	2011E	38141A	40938C

Figure 36: An example of a Qualification Match Schedule

Practice Match – A *Match* used to provide time for *Teams* and volunteers to get acquainted with the official playing field and procedures. *Practice Matches* earn *Teams* zero (0) *Win Points*, *Autonomous Points*, and *Strength of Schedule Points*.

Qualification Match – A *Match* used to determine *Team* rankings for *Alliance Selection*. Each *Qualification Match* consists of two *Alliances* competing to earn *Win Points*, *Autonomous Points*, and *Strength of Schedule Points*.

Scorekeeper Referee – An impartial volunteer responsible for tallying scores at the end of a *Match*. *Scorekeeper Referees* do not make ruling interpretations, and should redirect any *Team* questions regarding rules or scores to a *Head Referee*.

Strength of Schedule Points (SP) – The third basis of ranking *Teams*. *Strength of Schedule Points* are equivalent to the score of the losing *Alliance* in a *Qualification Match*. In the event of a tie, both *Alliances* receive SP's equal to the tie score. If both *Teams* on an *Alliance* are Disqualified, the *Teams* on the not Disqualified *Alliance* will receive their own score as SP's for that *Match*.

Time Out – A single break period no greater than three minutes (3:00) allotted for each *Alliance* during the *Elimination Bracket*. See <T9>.

Win Points (WP) – The first basis of ranking *Teams*. *Teams* will receive zero (0), one (1), two (2), or three (3) *Win Points* for each *Qualification Match*. Unless a *Team* is Disqualified, both *Teams* on an *Alliance* always earn the same number of WP's.

- One (1) WP is awarded for completing the *Autonomous Win Point* task(s).
- Two (2) WP's are awarded for winning a *Qualification Match*.
- One (1) WP is awarded for tying a *Qualification Match*.
- Zero (0) WP's are awarded for losing a *Qualification Match*.

Win Percentage (WP) – Replaces *Win Points* in a league event. *Win Percentage* is calculated by the number of wins divided by the number of *Qualification Matches* the team plays. In cases of a tie, the *Team* is given a 0.5 number of "wins" for that match. The *Autonomous Win Point* is also considered 0.5 "wins," added to the total number of wins.

Tournament Rules

<T1> Head Referees have ultimate and final authority on all gameplay ruling decisions during the competition.

- a. *Scorekeeper Referees* score the *Match*, and may serve as observers or advisers for *Head Referees*, but may not determine any rules or infractions directly.
- b. When issuing a *Major Violation* or *Minor Violation* to a *Team*, *Head Referees* must provide the rule number of the specific rule that has been Violated, and record the *Violation* on the Match Anomaly Log
- c. *Violations* of the REC Foundation Code of Conduct may involve additional escalation beyond a *Head Referee's* initial ruling, including (but not limited to) investigation by an REC Foundation representative. Rules <S1>, <G1>, and <G2> are the only rules for which this escalation may be required.
- d. *Event Partners* may not overrule a *Head Referee's* decision.
- e. Every *Qualification Match* and *Elimination Match* must be watched by a *Head Referee*.

Note from the VEX GDC: The rules contained in this Game Manual are written to be enforced by human *Head Referees*. Many rules have "black-and-white" criteria that can be easily checked. However, some rulings will rely on a judgment call from this human *Head Referee*. In these cases, *Head Referees* will make their calls based on what they and the *Scorekeeper Referees* saw, what guidance is provided by their official support materials (the Game Manual and the Q&A), and most crucially, the context of the *Match* in question.

The VEX Robotics Competition does not have video replay, our fields do not have absolute sensors to count scores, and most events do not have the resources for an extensive review conference between each *Match*.

When an ambiguous rule results in a controversial call, there is a natural instinct to wonder what the "right" ruling "should have been," or what the GDC "would have ruled." This is ultimately an irrelevant question; our answer is that when a rule specifies "*Head Referee's* discretion" (or similar), then the "right" call is the one made by a *Head Referee* in the moment. The VEX GDC designs games, and writes rules, with this expectation (constraint) in mind.

<T2> Head Referees must be qualified. *Head Referees* must have the following qualifications:

- a. Be at least 20 years of age.
- b. Be approved by the *Event Partner*.
- c. Be an REC Foundation Certified VRC *Head Referee* for the current season.

Note: Scorekeeper Referees must be at least 15 years of age, and must be approved by the Event Partner.

Head Referees should demonstrate the following attributes:

- Thorough knowledge of the current game and rules of play
- Effective decision-making skills
- Attention to detail
- Ability to work effectively as a member of a team
- Ability to be confident and assertive when necessary
- Strong communication and diplomacy skills

<T3> The Drive Team is permitted to immediately appeal a Head Referee's ruling. If *Drive Team Members* wish to dispute a score or ruling, they must stay in the *Alliance Station* until the *Head Referee* from the *Match* talks with them. The *Head Referee* may choose to meet with the *Drive Team Members* at another location and/or at a later time so that the *Head Referee* has time to reference materials or resources to help with the decision. Once the *Head Referee* announces that their decision has been made final, the issue is over and no more appeals may be made (See rule <T1>).

- a. *Head Referees* may not review any photo or video *Match* recordings when determining a score or ruling.
- b. *Head Referees* are the only individuals permitted to explain a rule, *Disqualification*, *Violation*, warning, or other penalty to the *Teams*. *Teams* should never consult other field personnel, including *Scorekeeper Referees*, regarding a ruling clarification.

Communication and conflict resolution skills are an important life skill for *Students* to practice and learn. In VEX Robotics Competitions, we expect *Students* to practice proper conflict resolution using the proper chain of command. *Violations* of this rule may be considered a *Violation* of <G1> and/or the Code of Conduct.

Some events may choose to utilize a "question box" or other designated location for discussions with *Head Referees*. Offering a "question box" is within the discretion of the *Event Partner* and/or *Head Referee*, and may act as an alternate option for asking *Drive Team Members* to remain in the *Alliance Station* (although all other aspects of this rule apply).

However, by using this alternate location, *Drive Team Members* acknowledge that they are forfeiting the opportunity to use any contextual information involving the specific state of the field at the end of the *Match*. For example, it is impossible to appeal whether a game element was *Scored* or not if the field has already been reset. If this information is pertinent to the appeal, *Drive Team Members* should still remain in the *Alliance Station*, and relocate to the "question box" once the *Head Referee* has been made aware of the concern and/or any relevant context.

<T4> The Event Partner has ultimate authority regarding all non-gameplay decisions during an event. The Game Manual is intended to provide a set of rules for successfully playing VRC Over Under; it is not intended to be an exhaustive compilation of guidelines for running a VEX Robotics Competition event. Rules such as, but not limited to, the following examples are at the discretion of the *Event Partner* and should be treated with the same respect as the Game Manual.

- Venue access
- Pit spaces
- Health and safety
- *Team* registration and/or competition eligibility
- *Team* conduct away from competition fields

This rule exists alongside <G1>, <S1>, and <G3>. Even though there isn't a rule that says "don't steal from the concession stand," it would still be within an *Event Partner's* authority to remove a thief from the competition.

<T5> A Team's Robot and/or Drive Team Member should attend every Match. A *Robot* or a *Student* member of the *Team* must report to the field for the *Team's* assigned *Match*, even if the *Robot* is not functional. If no *Student Drive Team Members* report to the field, the *Team* will be considered a "no-show" and receive zero (0) WP's, AP's, and SP's.

<T6> Robots at the field must be ready to play. If a *Team* brings their *Robot* to the field, it must be prepared to play (i.e., batteries charged, sized within the starting size constraint, displaying only the correct *Alliance*-color license plates, etc.).

- a. *Teams* who use VEX pneumatics must have their systems charged before they place the *Robot* on the field.
- b. *Robots* must be placed on the field promptly. Repeated failure to do so could result in a violation of <G1>. The exact definition of the term "promptly" is at the discretion of the *Head Referee* and *Event Partner*, who will consider event schedule, previous warnings or delays, etc.
- c. If a *Robot* is delaying the scheduled start of a *Match*, it may be removed from the field at the discretion of the *Head Referee* and *Event Partner*. A *Drive Team Member* may remain at the field so that the *Team* does not get assessed a "no-show" (per <T5>).

<T7> Match replays are allowed, but rare. *Match* replays (i.e., playing a *Match* over again from its start) must be agreed upon by both the *Event Partner* and *Head Referee*, and will only be issued in the most extreme circumstances. Some example situations that may warrant a *Match* replay are as follows:

- a. *Match Affecting* "field fault" issues.
 - i. Game Elements not starting in the correct positions.
 - ii. Tape lines lifting.
 - iii. Field Elements detaching or moving beyond normal tolerances (not as a result of *Robot* interactions).
 - iv. The *Autonomous Period* or *Driver Controlled Period* ending early.
 - v. Field control disconnecting or disabling *Robots*. Note, this is sometimes confused with a *Robot* whose motors have overheated, or bent pins on a controller's competition port causing intermittent drop-outs. In general, any true field fault will impact both *Alliances* simultaneously, not one *Robot* at a time.
- b. A V5 Robot Brain lockup that is outside of the *Team's* control and results in a complete shutdown of the *Robot*. To qualify for a *Match* replay, all of the following criteria must be met:
 - i. The screen on the V5 Brain turning completely white, including the status bar at the top of the screen.
 - ii. The Brain becoming unresponsive to any inputs from Controllers or sensors.
 - iii. The Brain becoming unresponsive to the "power" button on the Brain (i.e., the only way to reboot the Brain is to remove the battery).
 - iv. All connected devices not showing a solid red light at their Smart Port connections (i.e., blinking or off).
- c. *Match Affecting* game rule issues.
 - i. *Head Referee* disables a *Robot* for a misinterpretation of a rule *Violation*.
 - ii. *Head Referee* starts the *Driver Controlled Period* of the *Match* without determining the outcome of the *Autonomous Period* winner.
 - iii. The field is reset before a score is determined.

<T8> Disqualifications. When a *Team* receives a *Disqualification* in a *Qualification Match*, they receive zero (0) *Win Points*, *Autonomous Win Points*, *Autonomous Points*, and *Strength of Schedule Points*.

- a. If the *Team* receiving the *Disqualification* is on the winning *Alliance*, then *Teams* on the opposing *Alliance* who are not also *Disqualified* will receive the win for the *Match* and two (2) WP.
 - i. The *Team's* non-*Disqualified Alliance Partner* is unaffected, i.e. they will receive the win for the *Match* and two (2) WP.
- b. If the *Match* was a tie, then each *Team* on the opposing *Alliance* (the *Alliance* that did not receive the *Disqualification*) will receive the win for the *Match* and two (2) WP. If both *Alliances* have a *Team* receiving a *Disqualification*, then all non-*Disqualified Teams* will receive a tie for the *Match* and one (1) WP.
- c. *Autonomous Win Points* are not given to *Teams* that receive a *Disqualification*, and are not automatically awarded to the opposing *Alliance*.

When a *Team* is Disqualified in an *Elimination Match*, the entire *Alliance* is Disqualified; they receive a loss for the *Match*, and the opposing *Alliance* is awarded the win. If both *Alliances* receive a *Disqualification* in an *Elimination Match*, both *Alliances* receive a loss and will play another *Match* to determine a winner.

Note: If a Team is Disqualified in a Robot Skills Match, a score of zero (0) will be recorded for that Match.

<T9> Each Elimination Alliance gets one Time Out. Each *Alliance* may request one (1) *Time Out* during the *Elimination Bracket* between *Elimination Matches*, as permitted by the *Head Referee* and *Event Partner*. *Alliances* may not use their *Time Out* during a *Match*.

<T10> Be prepared for minor field variance. Field Element tolerances may vary from nominal by up to ± 1.0 ", unless otherwise specified in this Game Manual, Official Q&A, or Appendix A. *Triball* weights may vary from nominal by up to ± 20 grams. *Teams* are encouraged to design their *Robots* accordingly. Please make sure to check Appendix A for more specific nominal dimensions and tolerances.

Triball placement at the beginning of *Matches* may vary from nominal by up to ± 1 " (25.4mm). The rotation of *Triballs* is not specified.

<T11> Fields may be repaired at the Event Partner's discretion. All competition fields at an event must be set up in accordance with the specifications in Appendix A and/or other applicable Appendices. Minor aesthetic customizations or repairs are permitted, provided that they do not impact gameplay (see <T4>).

Examples of permissible modifications include, but are not limited to:

- Applying threadlocker to Field Element mounting hardware
- Taping over a hole in a damaged Net
- Using non-VEX white electrical tape to add required lines to the field

Examples of prohibited modifications include, but are not limited to:

- Unofficial field perimeter walls, additional structural elements inside of the field perimeter, or unofficial/replica Field Elements
- Additional VEX structural parts attached to a Field Element
- An unofficial replacement net
- Replacing the opaque field walls on the VEX Portable Competition Field Perimeter with transparent panels

Any specific repairs and/or modifications which pertain to the current season's game will be documented in this rule and Appendix A, as needed.

<T12> The red Alliance places last. The red *Alliance* has the right to place its *Robots* on the field last in both *Qualification Matches* and *Elimination Matches*. Once a *Team* has placed its *Robot* on the field, its position cannot be readjusted prior to the *Match*. If a *Team* chooses to reposition their *Robot* after it has already been placed, the opposing *Alliance* will also be given the opportunity to reposition their *Robots* promptly.

<T13> Qualification Matches follow the Match schedule. A *Qualification Match Schedule* will be available on the day of competition. The *Match Schedule* will indicate *Alliance* partners, *Match* pairings, and *Alliance* colors for each *Match*. For tournaments with multiple fields, the schedule will indicate which field each *Match* will take place on. The *Match Schedule* is subject to change at the *Event Partner's* discretion. Any multi-division event must be approved by the REC Foundation EEM/RSM prior to the event, and divisions must be assigned in sequential order by *Team* number.

<T14> Each Team will have at least six Qualification Matches

- a. When in a tournament, the tournament must have a minimum of six (6) *Qualification Matches* per *Team*. The suggested amount of *Qualification Matches* per *Team* for a standard tournament is eight (8) and up to ten (10) for a championship event.
- b. When in a league, there must be at least three (3) league ranking sessions, with at least one (1) week between sessions. Each session must have a minimum of two (2) *Qualification Matches* per *Team*. The suggested amount of *Qualification Matches* per *Team* for a standard league ranking session is four (4). Leagues will have a championship session where elimination rounds will be played. *Event Partners* may choose to have *Qualification Matches* as part of their championship session.

<T15> Qualification Matches contribute to a Team's ranking for Alliance Selection

- a. When in a tournament, every *Team* will be ranked based on the same number of *Qualification Matches*.
- b. When in a league, every *Team* will be ranked based on the number of *Matches* played. *Teams* that participate at least 60% of the total *Matches* available will be ranked above *Teams* that participate in less than 60% of the total *Matches* available; e.g., if the league offers 3 ranking sessions with 4 *Qualification Matches* per *Team*, teams that participate in 8 or more *Matches* will be ranked higher than *Teams* who participate in 7 or fewer *Matches*. Being a no-show to a *Match* that a *Team* is scheduled in still constitutes participation for these calculations.
- c. In some cases, a *Team* will be asked to play an additional *Qualification Match*. The extra *Match* will be identified on the *Match Schedule* with an asterisk; WP's, AP's, and SP's for that *Qualification Match* will not impact a *Team's* ranking, and will not affect participation percentage for leagues.
 - i. *Teams* are reminded that <G1> is always in effect and *Teams* are expected to behave as if the additional *Qualification Match* counted.

- ii. In Leagues, *Teams* may have a different number of *Qualification Matches*. Rankings are determined by the *Win Percentage*, which is the number of wins divided by the number of *Qualification Matches* that *Teams* has played.

<T16> Qualification Match tiebreakers. *Team* rankings are determined throughout *Qualification Matches* as follows:

- a. Average *Win Points* (WP / Number of *Matches* played)
- b. Average *Autonomous Points* (AP / Number of *Matches* played)
- c. Average *Strength of Schedule Points* (SP / Number of *Matches* played)
- d. Highest *Match* score
- e. Second highest *Match* score
- f. Random electronic draw

<T17> Send a Student representative to Alliance Selection. Each *Team* must send one (1) *Student* representative to the playing field (or other designated area) to participate in *Alliance Selection*. If the *Team* Representative fails to report in for *Alliance Selection*, their *Team* will be ineligible for participation in the *Alliance Selection* process.

<T18> Each Team may only be invited once to join one Alliance. If a *Team* representative declines an *Alliance Captain's* invitation during *Alliance Selection*, that *Team* is no longer eligible to be selected by another *Alliance Captain*. However, they are still eligible to play *Elimination Matches* as an *Alliance Captain*.

For example:

- *Alliance Captain* 1 invites *Team ABC* to join their *Alliance*.
- *Team ABC* declines the invitation.
- No other *Alliance Captains* may invite *Team ABC* to join their *Alliance*.
- However, *Team ABC* may still form their own *Alliance*, if *Team ABC* ranked high enough after *Qualification Matches* to become an *Alliance Captain*.

<T19> Elimination Matches follow the Elimination Bracket. A sixteen (16) *Alliance* bracket plays as shown in Figure 37:

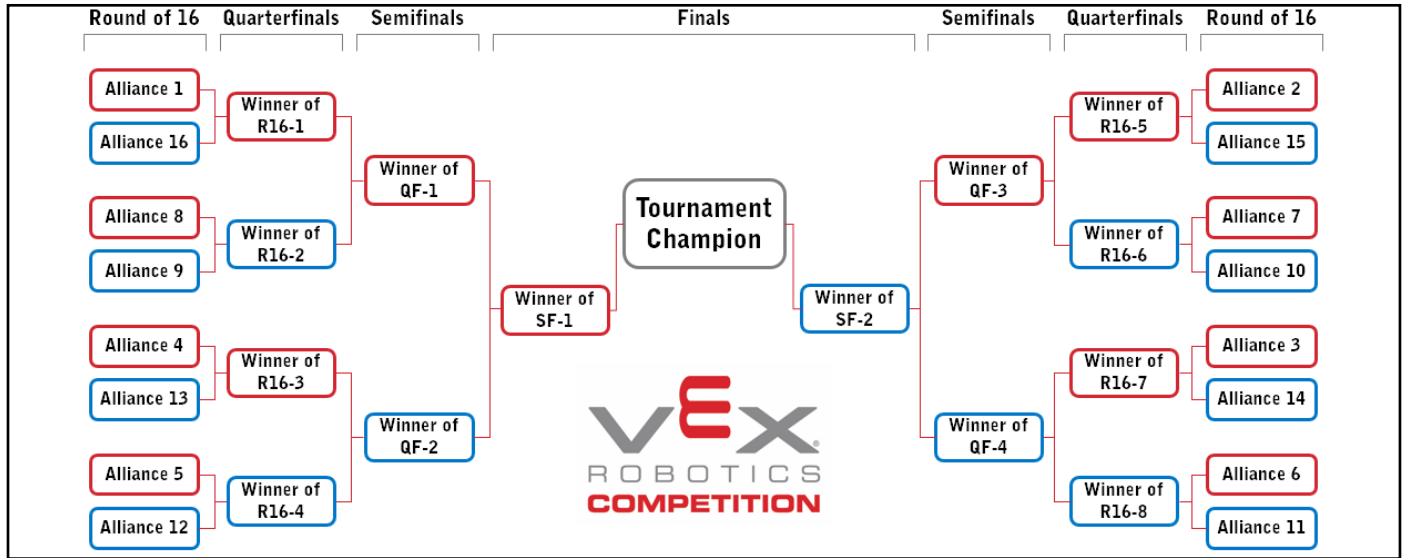

Figure 37: A 16-Alliance bracket

If an event is run with fewer than sixteen (16) *Alliances*, then they will use the bracket shown above, with *Byes* awarded when there is no applicable *Alliance*. For example, in a tournament with twelve (12) *Alliances*, *Alliances* 1, 2, 3, & 4 would automatically advance to the Quarterfinals.

Thus, an eight (8) *Alliance* bracket would run as shown in Figure 38:

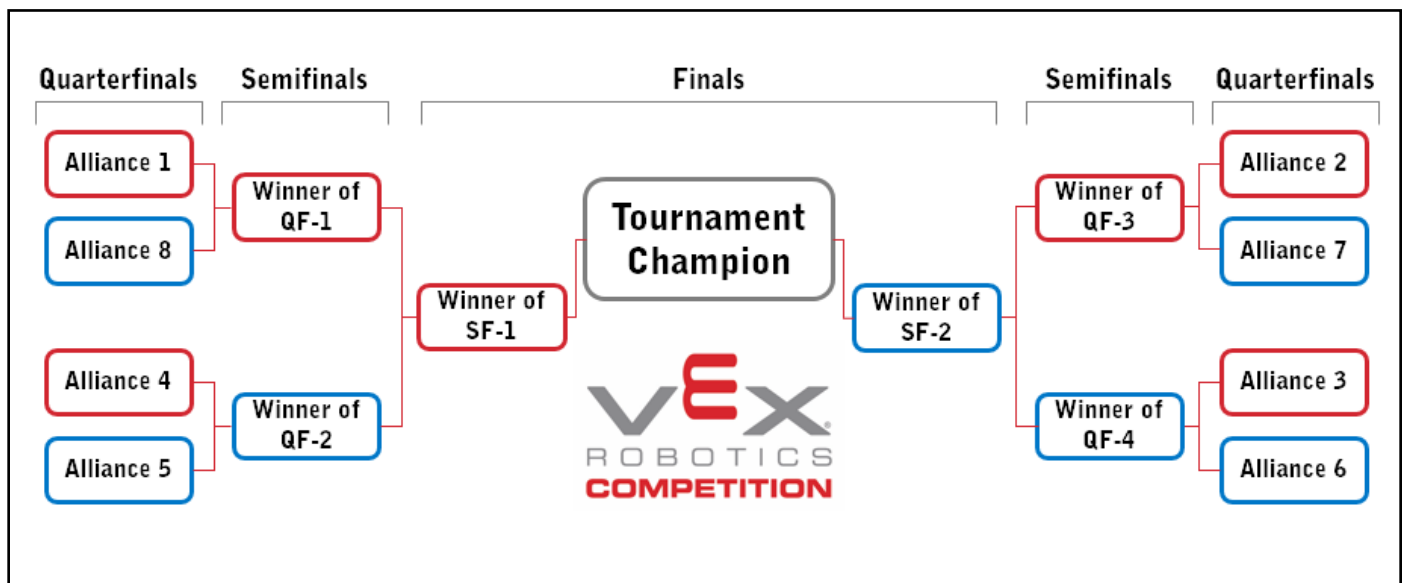

Figure 38: An 8-Alliance bracket

<T20> **Elimination Matches are a blend of "Best of 1" and "Best of 3."** "Best of 1" means that the winning *Alliance* in each *Match* advances to the next round of the *Elimination Bracket*. "Best of 3" means that the first *Alliance* to reach two wins will advance.

See the Flowchart in Figure 39 for more information.

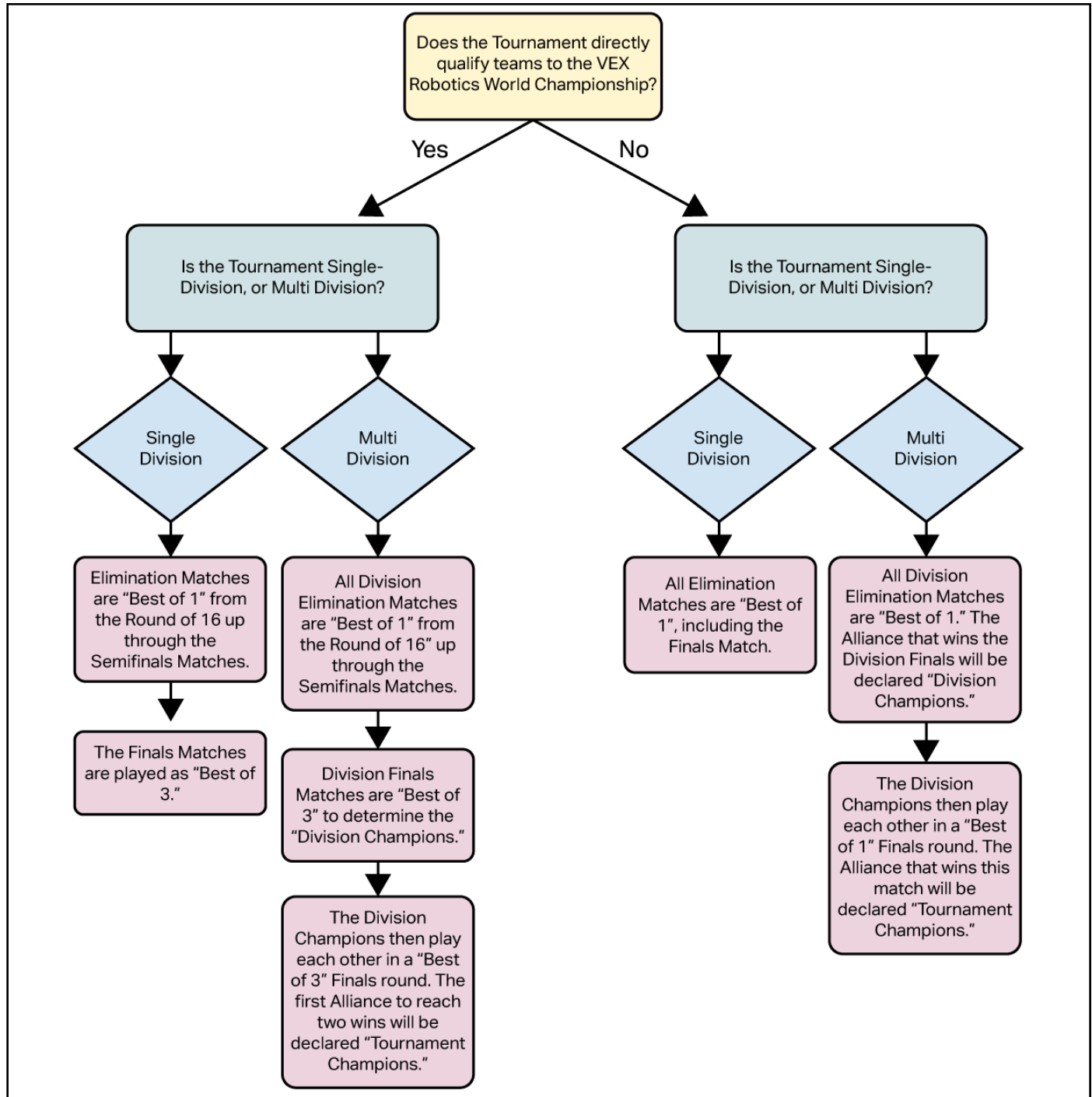

Figure 39: The process for determining how Elimination Matches should be played.

<T21> Small tournaments may have fewer Alliances. The number of *Alliances* for a given event is determined as follows:

# of Teams	# of Elimination Alliances
32+	16
24-31	12
16-23	8
<16	# of <i>Teams</i> divided by 2, less any remainder

<T22> Fields at an event must be consistent with each other. There are many types of permissible aesthetic and/or logistical modifications that may be made to competition fields at the *Event Partner's* discretion. If an event has multiple Head-to-Head competition fields, they must all incorporate the same permissible/applicable modifications. For example, if one field is elevated, then all Head-to-Head competition fields must be elevated to the same height.

Examples of these modifications may include, but are not limited to:

- Elevating the playing field off of the floor (common heights are 12" to 24" [30.5cm to 61cm])
- Field control systems (see <T23>)
- Field display monitors
- Field perimeter decorations (e.g., LED lights, sponsor decals on polycarbonate panels)
- Field perimeter type (see <T24>)
- Utilizing the VEX GPS Field Code Strips

Note: If an event has dedicated fields for Skills Challenge Matches, there is no requirement for them to have the same consistent modifications as the Head-to-Head fields. See <RSC6> for more details.

<T23> There are three types of field control that may be used:

1. A VEXnet Field Controller, which connects to a Controller's competition port via Cat-5 cable.
2. A V5 Event Brain, which connects to a Controller via Smart Cable.
3. A VEXnet Competition Switch, which connects to a Controller's competition port via Cat-5 cable, may only be used in *Practice Matches* or *Robot Skills Matches*, and only under extreme circumstances.

If an event has multiple fields, then all fields of the same game type must use the same control system, in accordance with <T23> and <RSC6>. For example, it would be permissible for Head-to-Head competition fields to use V5 Event Brains, and for Skills Challenge fields to use VEXnet Field Controllers.

However, it would not be permissible for one Head-to-Head field to use a V5 Event Brain while another Head-to-Head field uses a VEXnet Field Controller.

Note: Event Partners may only use the official, unmodified version of Tournament Manager along with approved hardware and networking solutions found in the REC Library. Using non-standard software and hardware will not be supported by the REC Foundation or VEX Robotics and is done at your own risk. For questions, please contact your REC Foundation Manager.

<T24>There are two types of Field Perimeter that may be used:

1. VEX Metal Competition Field Perimeter (SKU 278-1501)
2. VEX Portable Competition Field Perimeter (SKU 276-8242)

See Appendix A for more details.

If an event has multiple fields, then all fields of the same game type must use the same Field Perimeter type, in accordance with <T22> and <RSC6>. For example, it would be permissible for Head-to-Head competition fields to use metal Field Perimeters, and for Skills Challenge fields to use Portable Field Perimeters. However, it would not be permissible for one Head-to-Head field to use a metal Field Perimeter, while other Head-to-Head fields use Portable Field Perimeters.

Note: See <RSC6> for more details specific to Skills Challenge fields.

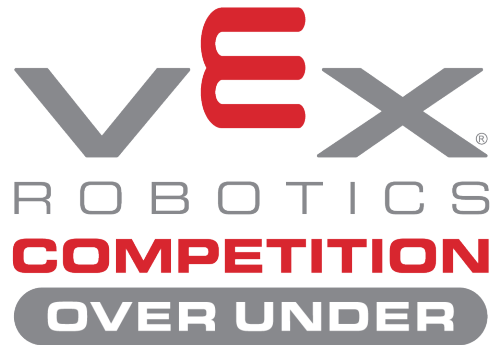

2023 - 2024

Appendix A - Field Overview and Specifications

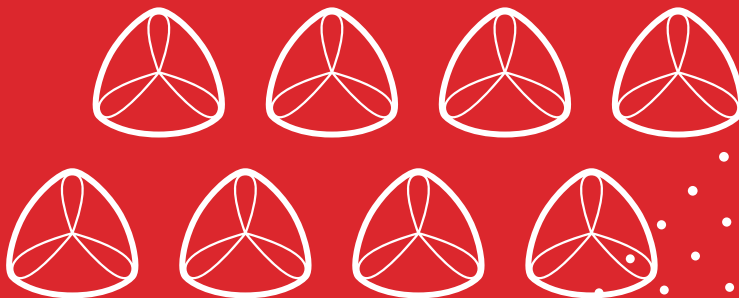

Appendix A - Field Overview

Game Field Introduction

This document will provide Bill of Materials (BOM) information and detailed specifications for the Official Competition Field.

Teams who do not need an “official” field should refer to the separate low-cost field guide for cost reduction options. *Teams* assembling the full field should refer to the separate VEX Robotics Competition Over Under Field Build Instructions.

Please note: this field can utilize both the [VEX Portable Competition Field Perimeter \(276-8242\)](#) and the [VEX Competition Field Perimeter \(278-1501\)](#) developed by VEX Robotics. Instructions and specifications for these field perimeters are available in separate documents and are important for the field assembly.

This document is divided up into three sections:

1. Field Overview
2. Field BOM
3. Field Specifications

There is also an accompanying STEP file which can be imported into most 3D modeling programs (e.g., Inventor, Sketchup, Solidworks, etc.). This 3D model shows the “official” setup of a VEX Robotics Competition - Over Under competition field, as well as detailed models of individual Field Elements.

For additional game-play detail, please refer to the VEX Robotics Competition Over Under Game Manual.

Field Overview

The game VEX Robotics Competition Over Under is played on a 12ft x 12ft foam mat, surrounded by a perimeter, and divided in half by a barrier spanning the length of the field.

The VRC Over Under field consists of sixty (60) Triballs. Each Alliance has one (1) Goal, two (2) Match Load Zones and one (1) set of Alliance Elevation Bars. Each half of the field includes an Offensive Zone, which is partially defined by the Barrier and Goals. A Goal is located alongside the wall closest to each Alliance Station.

For more details and specific gameplay rules, please refer to the VEX Robotics Competition Over Under Game Manual.

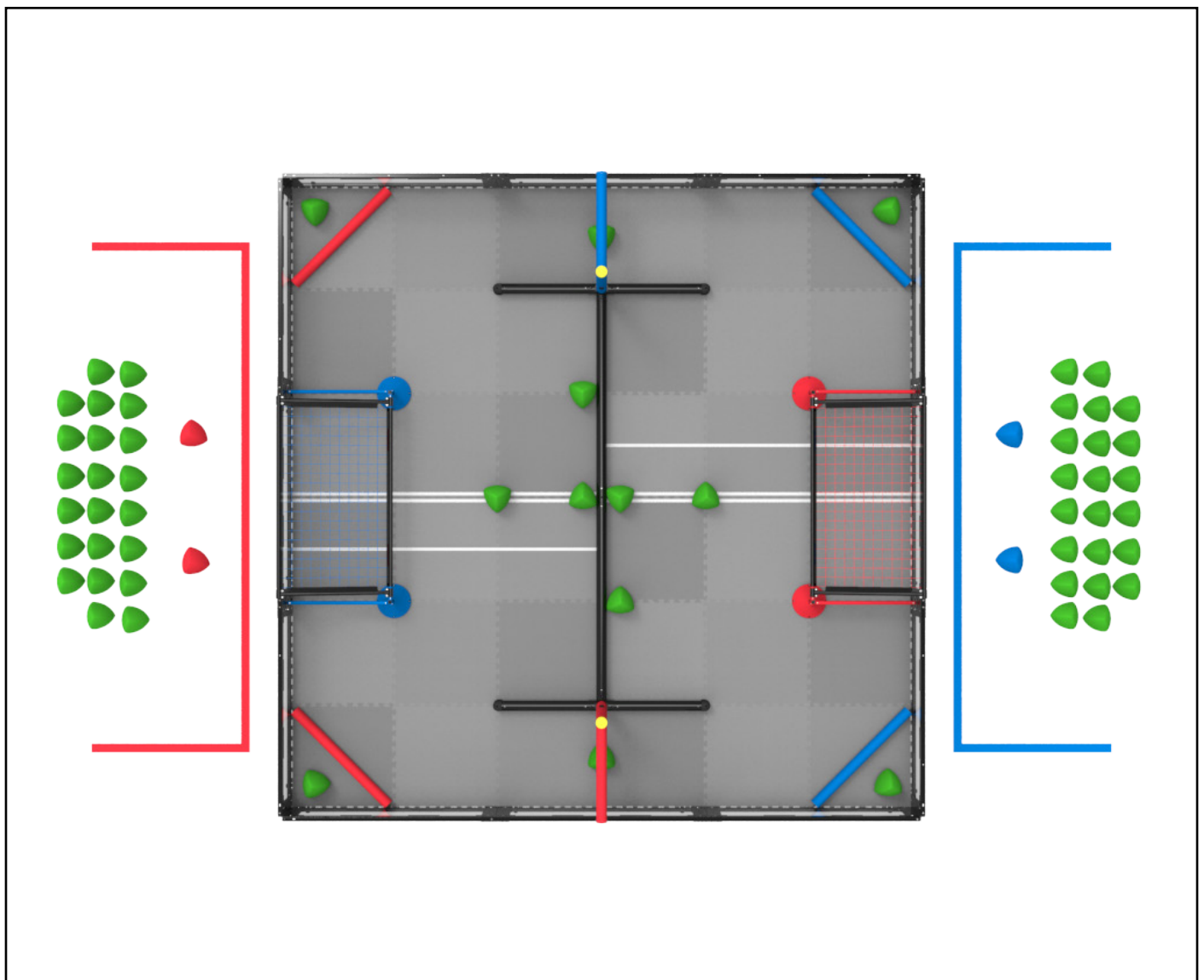

Game Objects & Field Bill of Materials

All of these items are available for purchase from www.vexrobotics.com

Generic Field Elements - Reusable Each Year

Part Number	Description
278-1501	VRC Field Perimeter Frame & Hardware
276-8242	VRC Portable Competition Field Perimeter
276-6905	VRC Anti-Static Field Tiles (18-Pack)
275-1401	VRC VEXnet Field Controller

Official VEX Robotics Competition Over Under Specific Elements

Part Number	Description	Quantity per Full Field
276-8354	VRC Over Under Full Field & Game Element Kit	
276-8355	VRC Over Under Game Element Kit	2
276-8356	VRC Over Under Field Element Kit 1	1
276-8357	VRC Over Under Field Element Kit 2	1
276-8905	VRC Over Under Field Element Kit 3	1

Practice Elements

Part Number	Description
276-8355	VRC Over Under Game Element Kit
276-XXXX	VRC Over Under Scoring Element Kit

Field Specifications Introduction

This section will outline the specifications that are most important to *Teams* designing a *Robot* to compete in the VEX Robotics Competition Over Under. Though many of the critical dimensions are included in this section, it may be necessary to consult the separate assembly guide and 3D CAD models of the field for an additional level of detail. If you can't find a dimension in the specifications, we include a full model of the field to "virtually" measure whatever dimension is necessary.

Field components may vary slightly from event to event. This is to be expected; *Teams* will need to adapt accordingly. It is good design practice to create mechanisms capable of accommodating variances in the field and game pieces.

Note: Minor field repairs are permissible, provided that the repairs do not affect gameplay. Examples of minor field repairs include (but are not limited to) threadlocker applied to Field Element mounting hardware or tape over a hole in a damaged Net. Be sure to check the Official Q&A for specific examples or to get an official clarification.

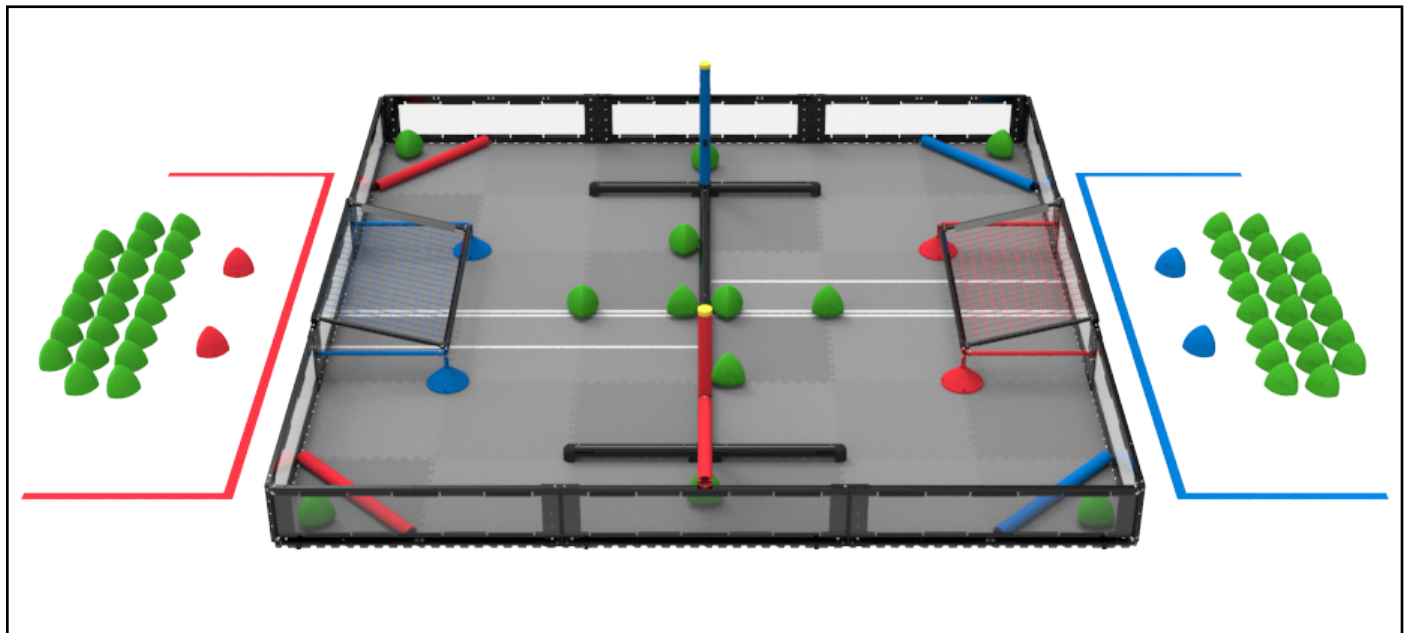

Scoring Objects are placed as follows before the start of each Match

1. (2x) Alliance colored triballs for preload. One per team.
2. (22x) Triballs outside the field for Alliance match loads.
3. (1x) Triball centered under the low elevation bar.
4. (1x) Triball touching the Barrier half way between the Autonomous Line and the Elevation Bar on the side of the Autonomous Line without a neutral zone.
5. (1x) Triball touching the Barrier and the Autonomous Line.
6. (1x) Triball between the Goal and the Barrier on the Autonomous Line.
7. (1x) Triball in each Match Load Zone.

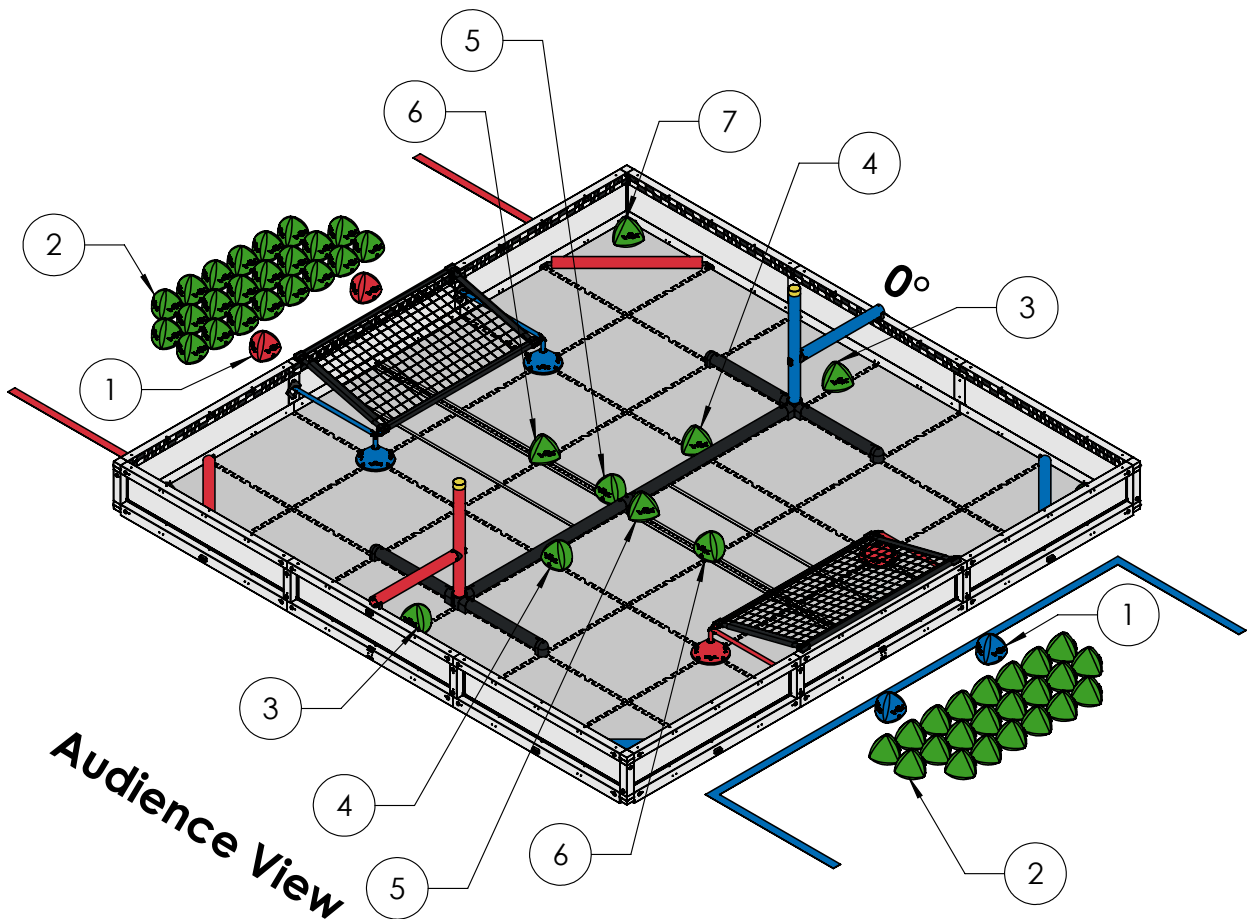

Audience View

Reference Object Placement Image:

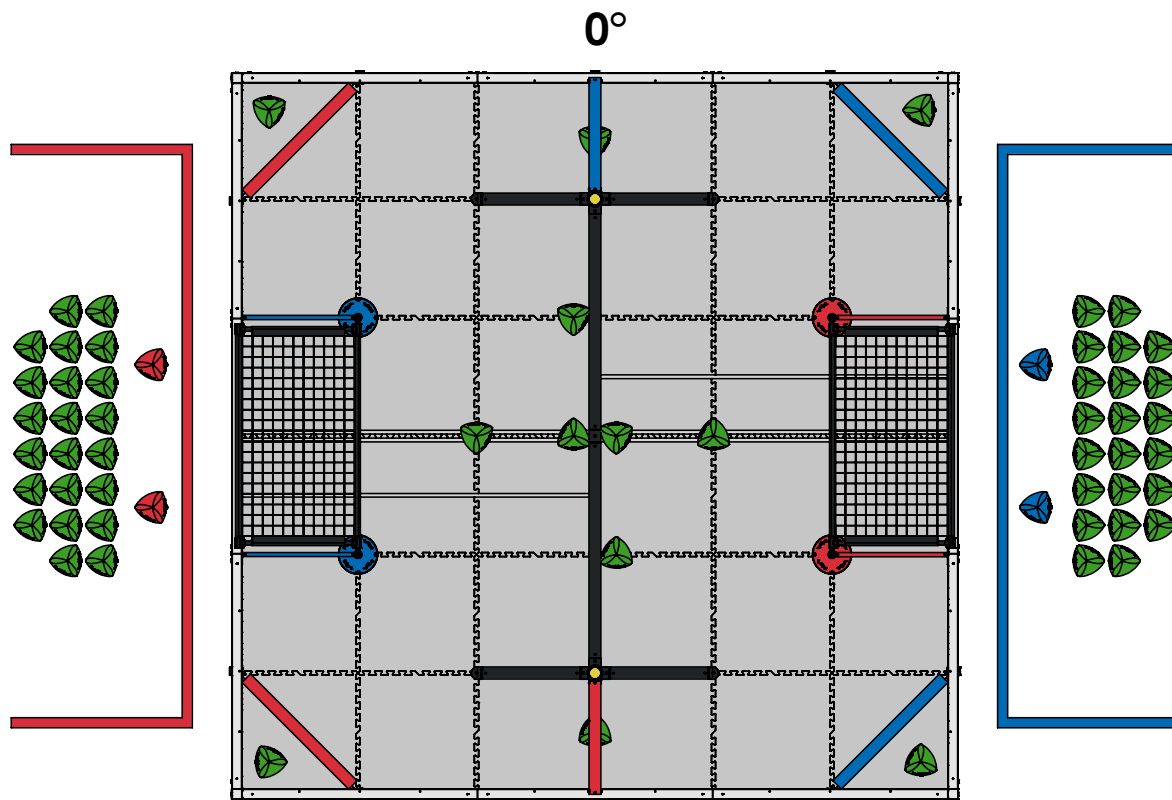

Audience View

Reference Object Placement Skills Layout Image:

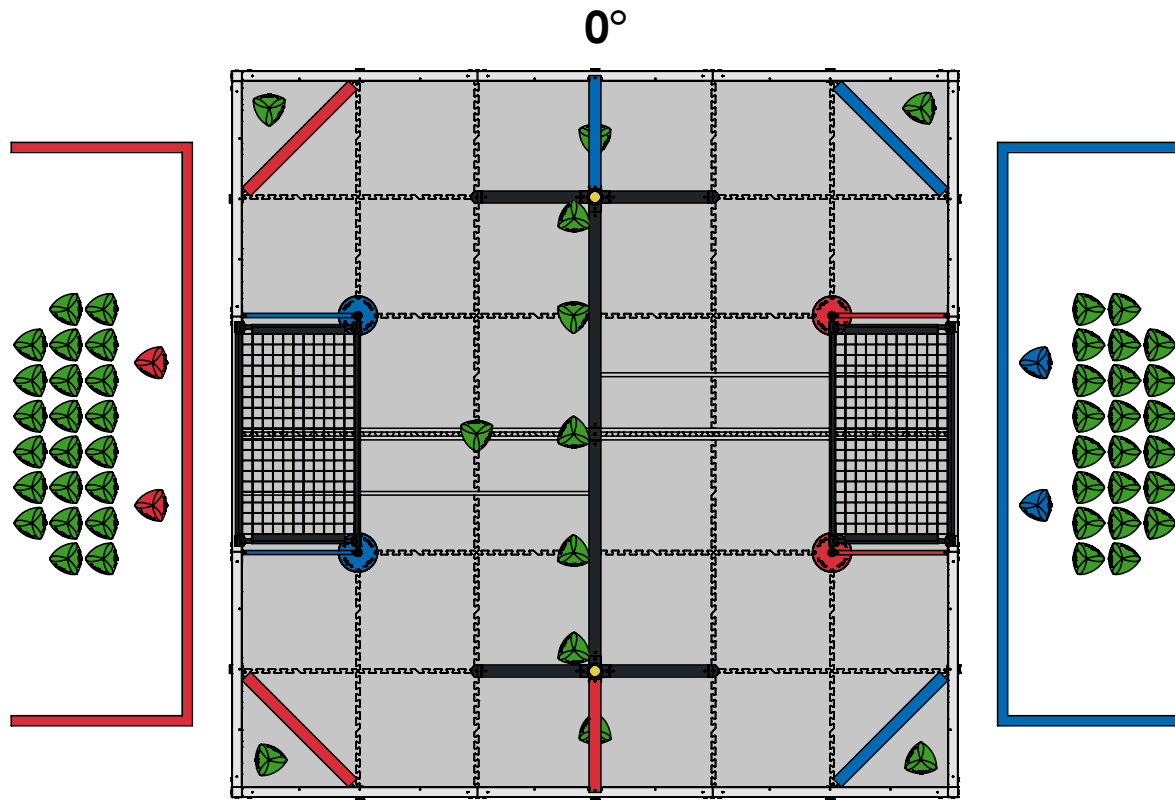

Audience View

Field Critical Specs (276- 8242):

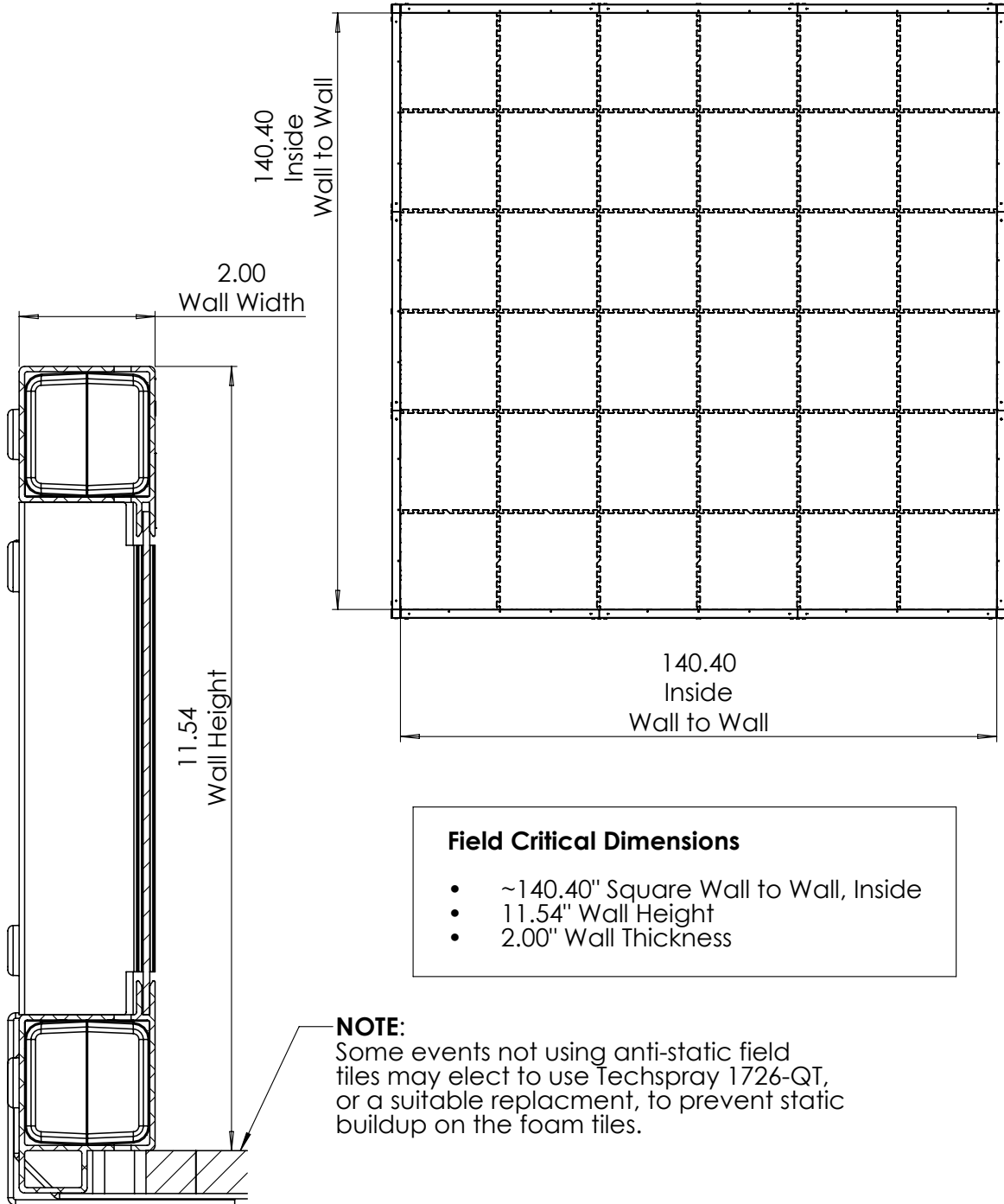

Field Critical Specs (278- 1501):

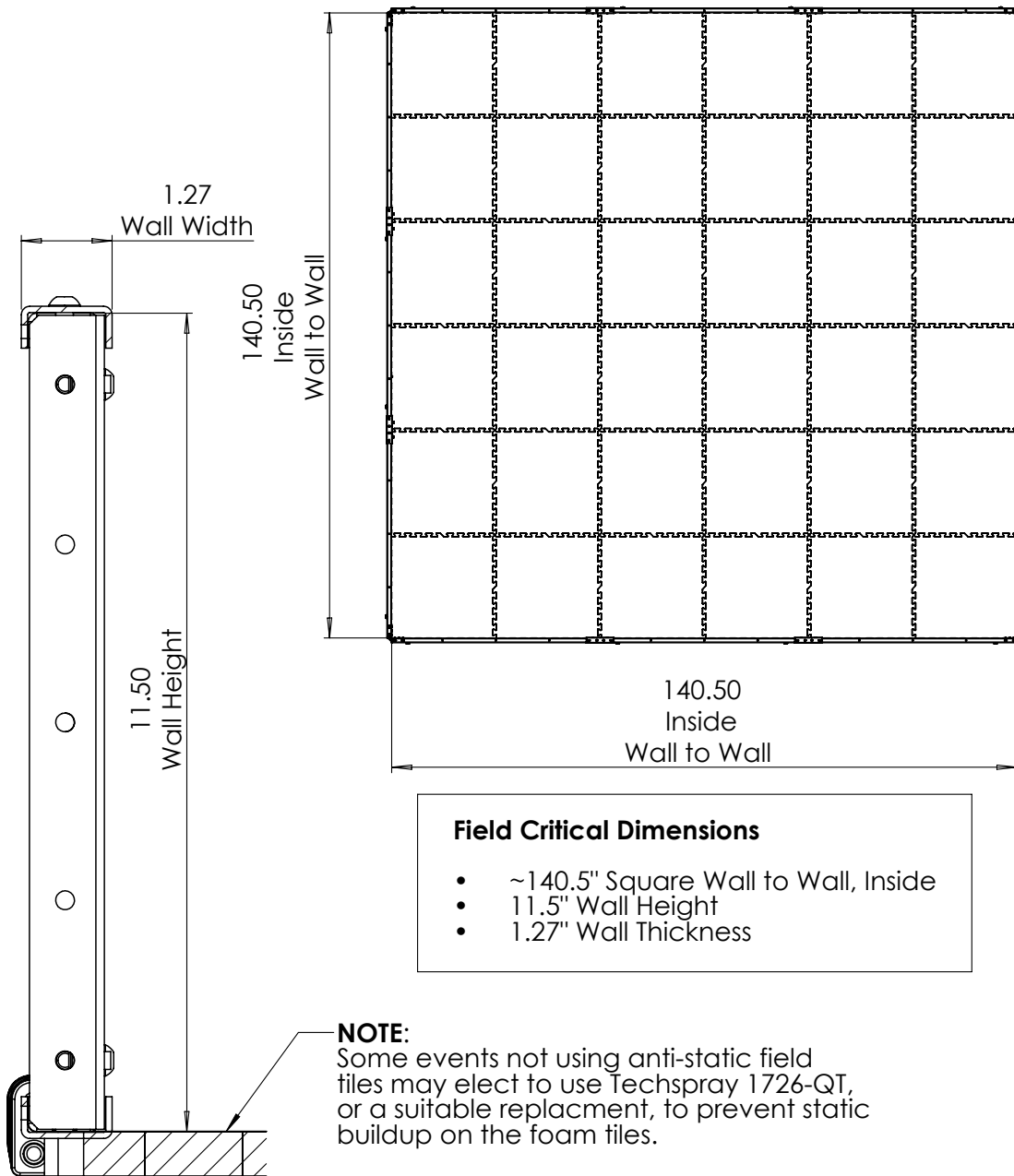

	Description		Field Perimeter Specifications (2)
	Dwg No		276-8354-000 Field Specifications
	Competition	VRC 2023-2024	Sheet 5 of 15
	Release	1/31/2023	ALL DIMENSIONS ARE IN INCHES.

www.VEXROBOTICS.COM

Triball Specs:

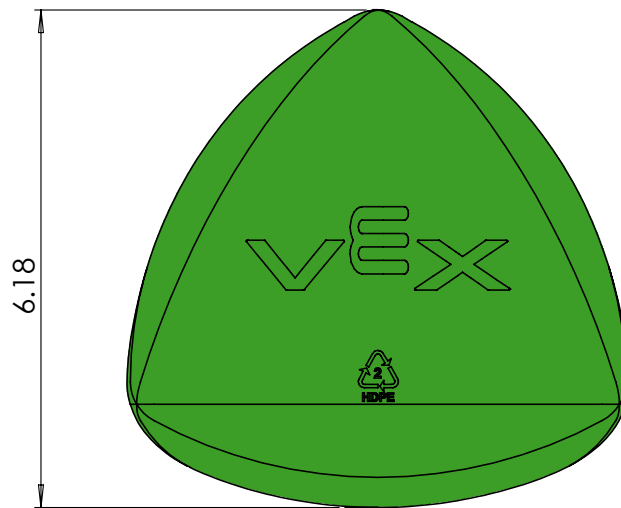
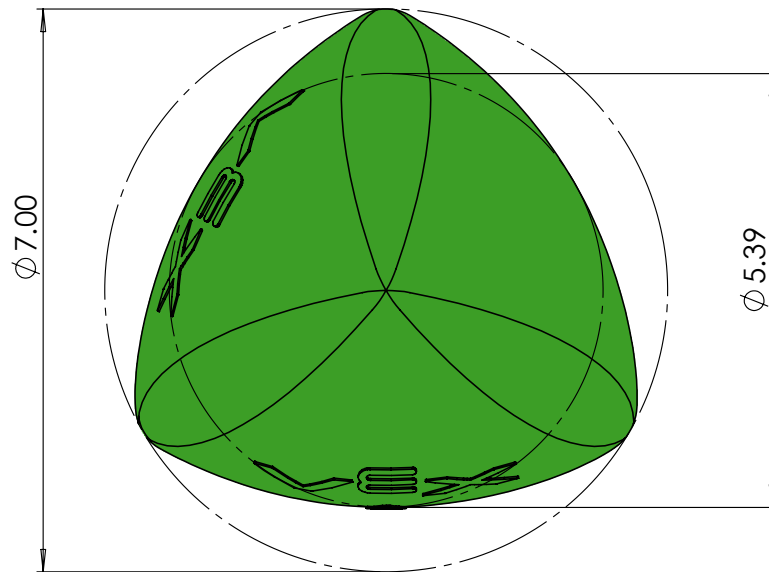

Mass: 110 ± 20 Grams



Description	2023-2024 Game Specifications	
Dwg No	276-8354-000 Field Specifications	
Competition	VRC 2023-2024	Sheet 6 of 15
Release	1/31/2023	ALL DIMENSIONS ARE IN INCHES.

www.VEXROBOTICS.COM

Goal Specs:

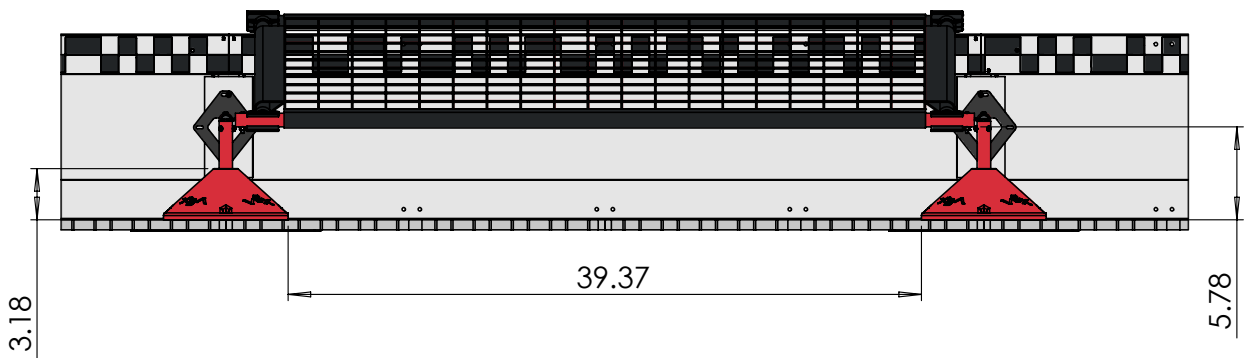
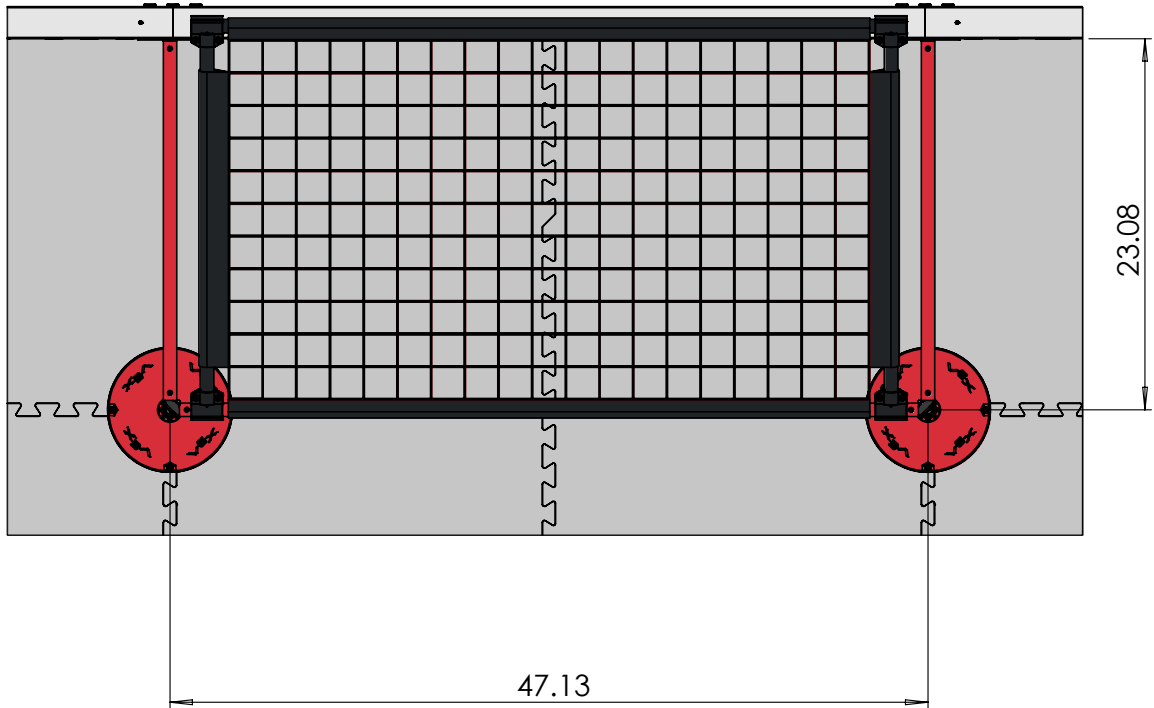

Goal Specs:

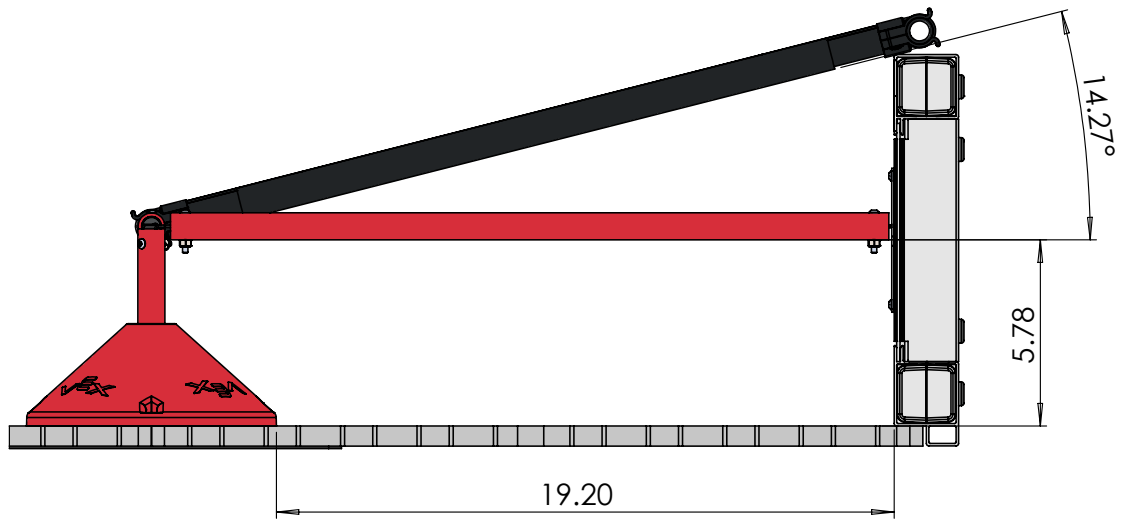

	Description 2023-2024 Game Specifications (3)	
	Dwg No 276-8354-000 Field Specifications	
	Competition VRC 2023-2024	Sheet 8 of 15
	Release 1/31/2023	ALL DIMENSIONS ARE IN INCHES.

Barrier Specs:

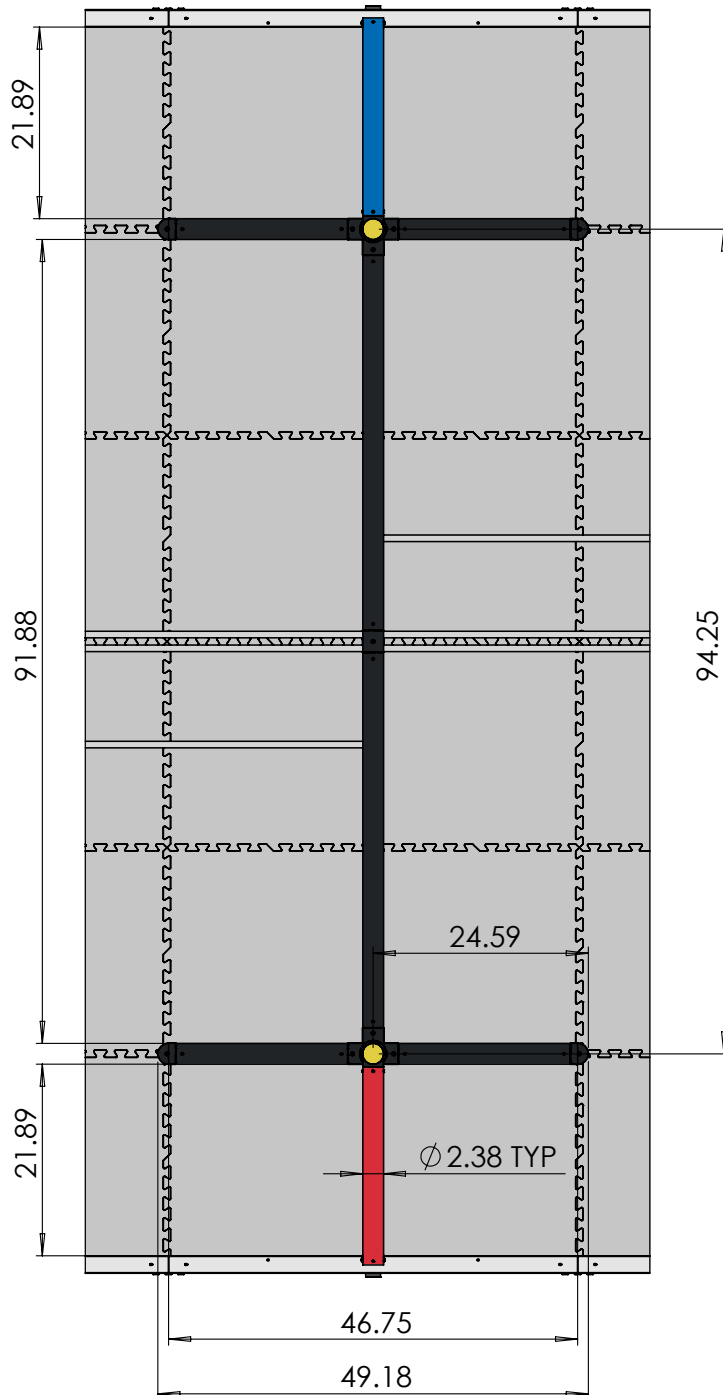

	Description 2023-2024 Game Specifications (4)	
	Dwg No 276-8354-000 Field Specifications	
	Competition VRC 2023-2024	Sheet 9 of 15
	Release 1/31/2023	ALL DIMENSIONS ARE IN INCHES.

www.VEXROBOTICS.com

Barrier Specs:

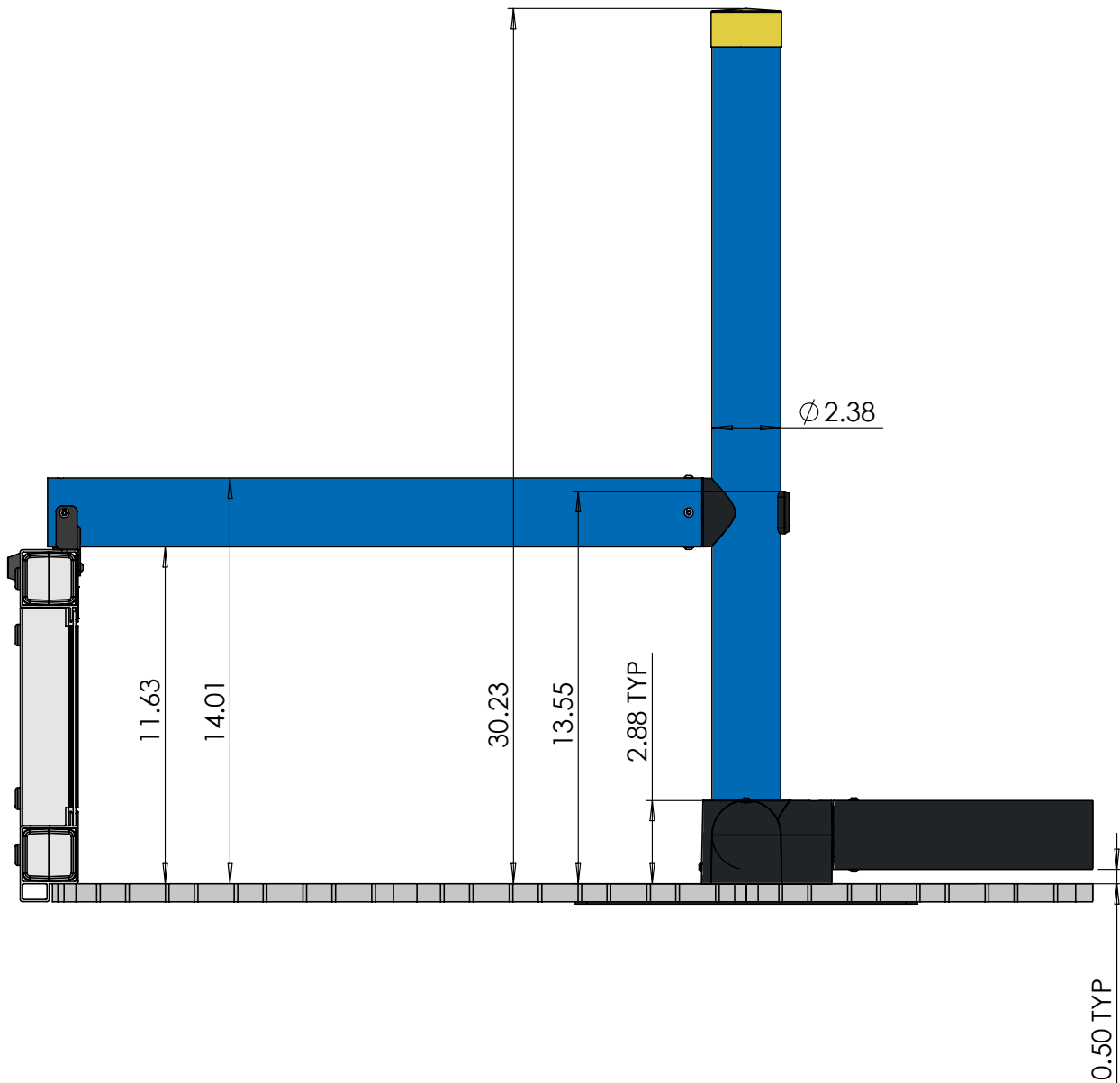

	Description 2023-2024 Game Specifications (5)	
	Dwg No 276-8354-000 Field Specifications	
	Competition VRC 2023-2024	Sheet 10 of 15
	Release 1/31/2023	ALL DIMENSIONS ARE IN INCHES.
		www.VEXROBOTICS.COM

Load Zone Specs:

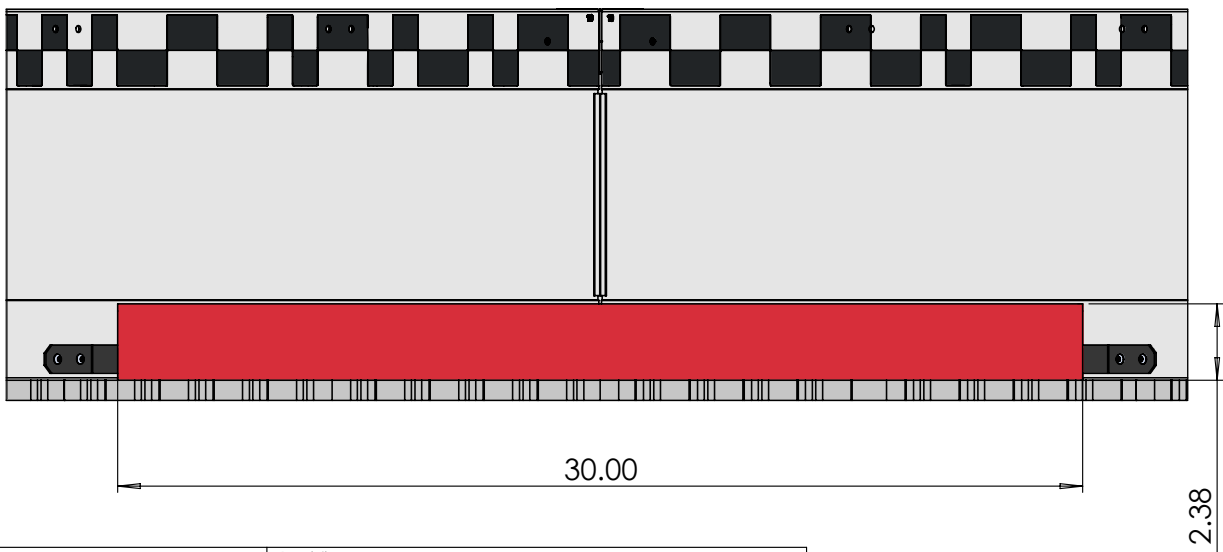
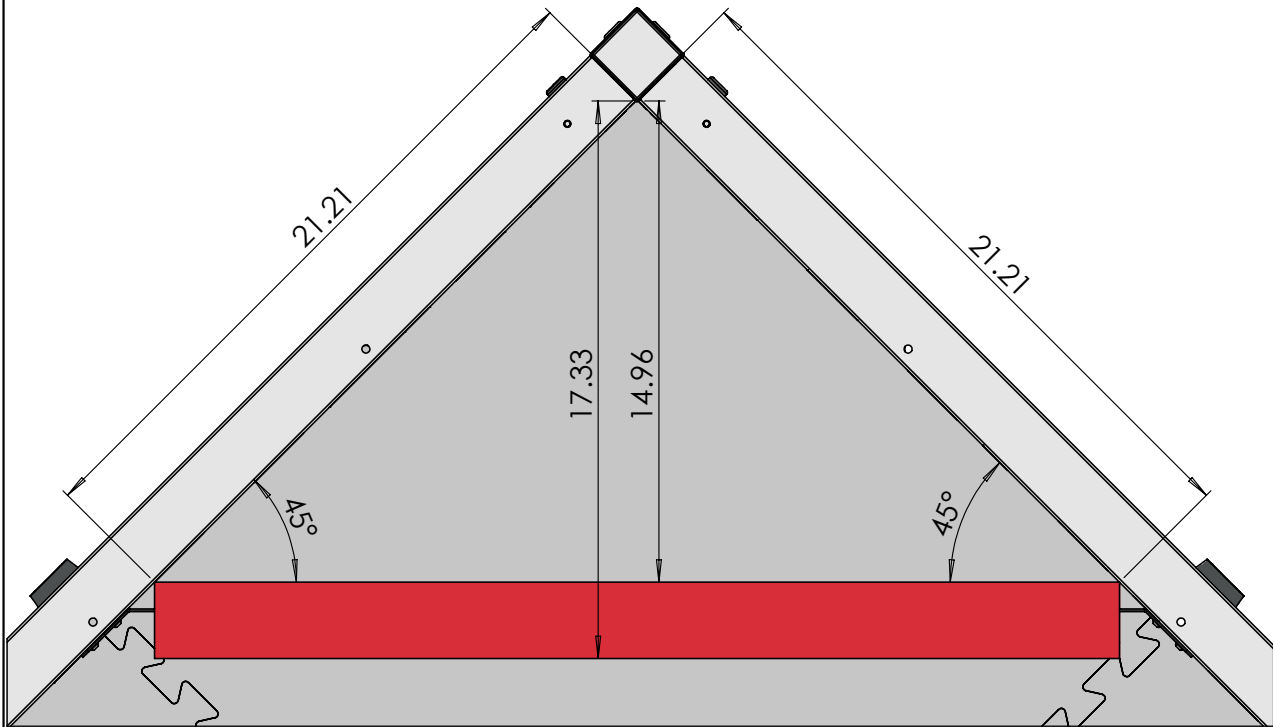

	Description 2023-2024 Game Specifications (6)	
	Dwg No 276-8354-000 Field Specifications	
	Competition VRC 2023-2024	Sheet 11 of 15
	Release 1/31/2023	ALL DIMENSIONS ARE IN INCHES.

Measurement Stick Specs:

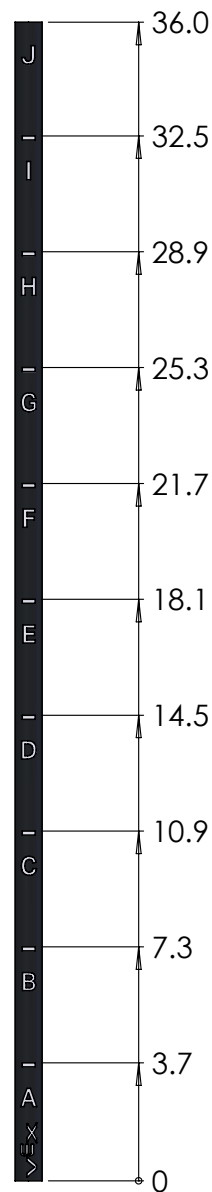

	Description 2023-2024 Game Specifications (7)	
	Dwg No 276-8354-000 Field Specifications	
	Competition VRC 2023-2024	Sheet 12 of 15
	Release 1/31/2023	ALL DIMENSIONS ARE IN INCHES.
		www.VEXROBOTICS.COM

Field Reference Specs:

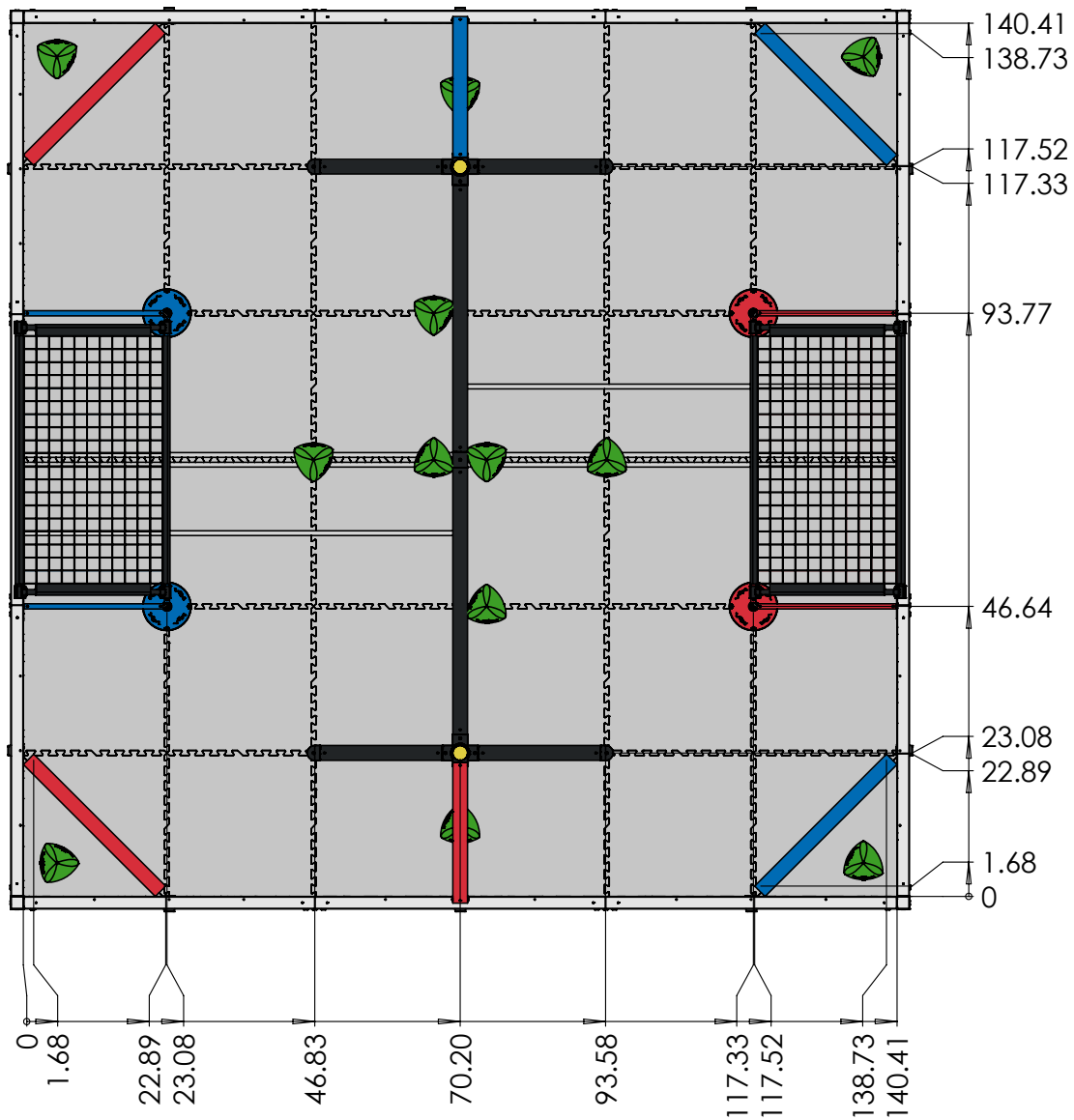

Description	2023-2024 Game Specifications (8)	
Dwg No	276-8354-000 Field Specifications	
Competition	VRC 2023-2024	Sheet 13 of 15
Release	1/31/2023	ALL DIMENSIONS ARE IN INCHES.

www.VEXROBOTICS.COM

Field Reference Specs:

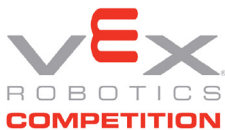
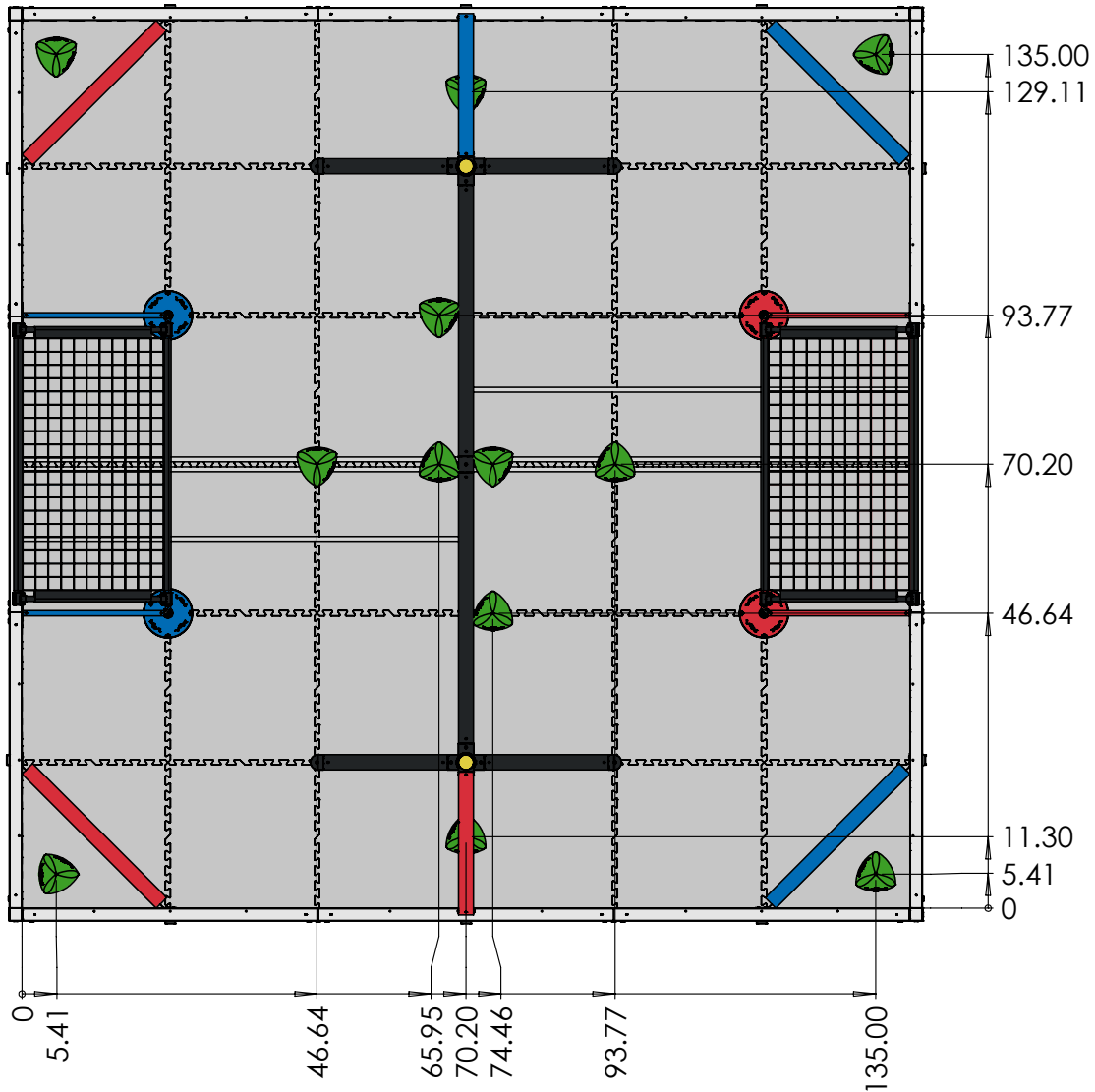

Description	2023-2024 Game Specifications (9)	
Dwg No	276-8354-000 Field Specifications	
Competition	VRC 2023-2024	Sheet 14 of 15
Release	1/31/2023	ALL DIMENSIONS ARE IN INCHES.

www.VEXROBOTICS.COM

Field Reference Specs Skills Layout:

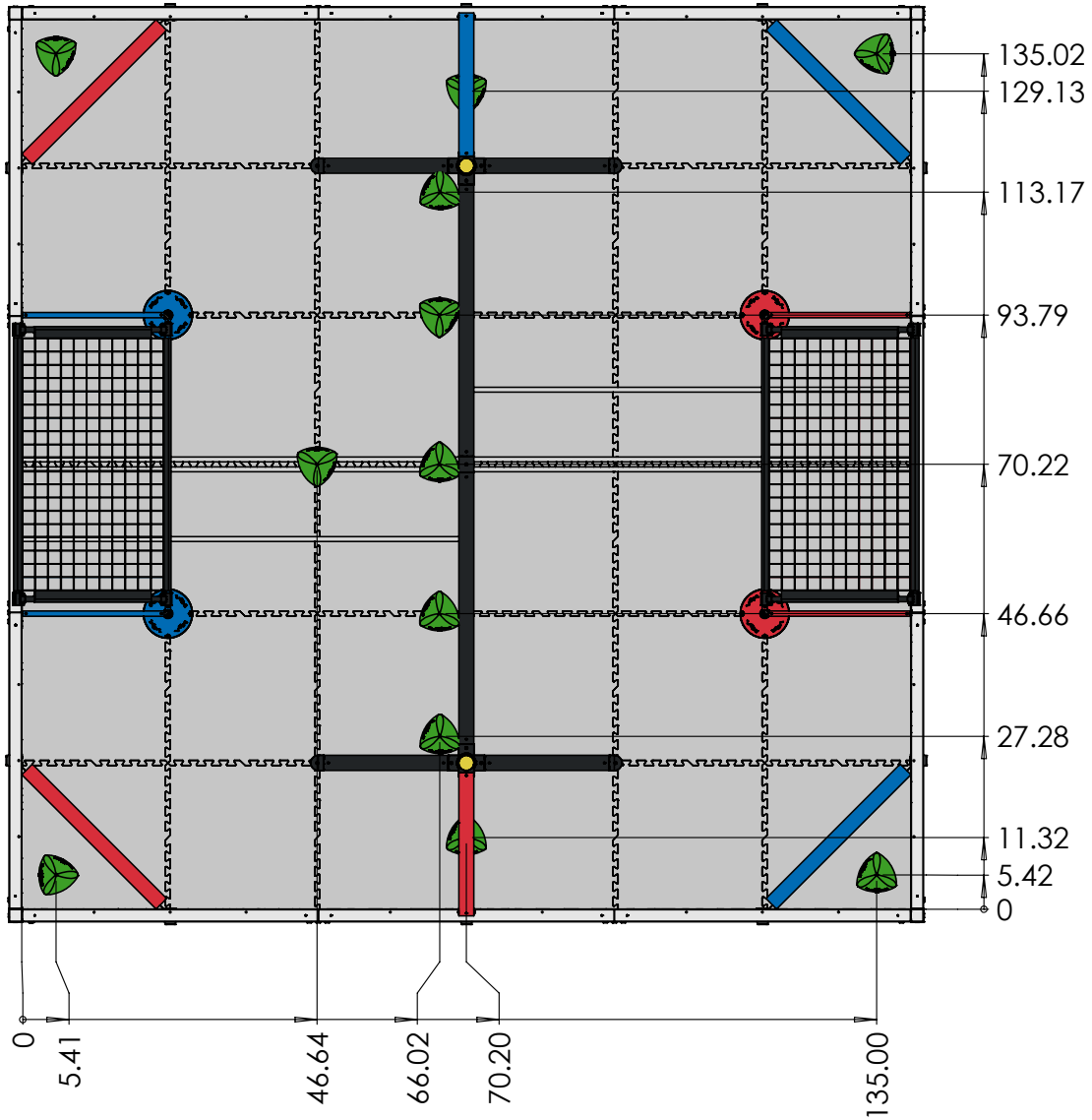

Description	2023-2024 Game Specifications (10)	
Dwg No	276-8354-000 Field Specifications	
Competition	VRC 2023-2024	Sheet 15 of 15
Release	1/31/2023	ALL DIMENSIONS ARE IN INCHES.

www.VEXROBOTICS.COM

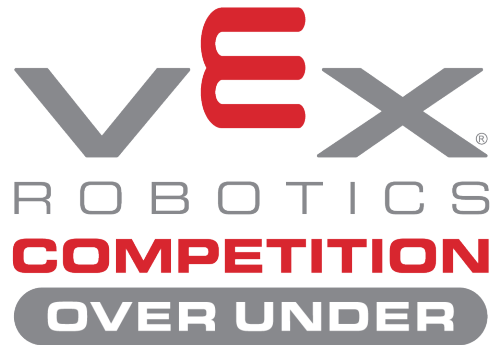
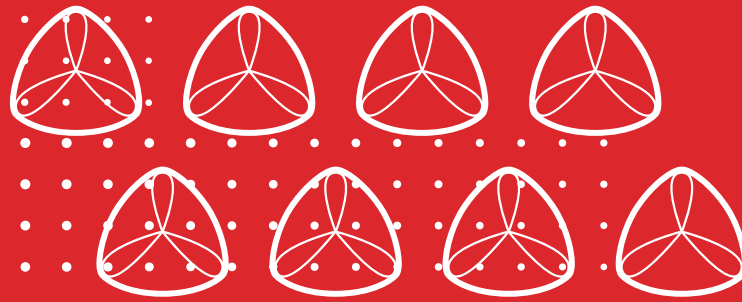

2023 - 2024
Appendix B - Robot Skills Challenge

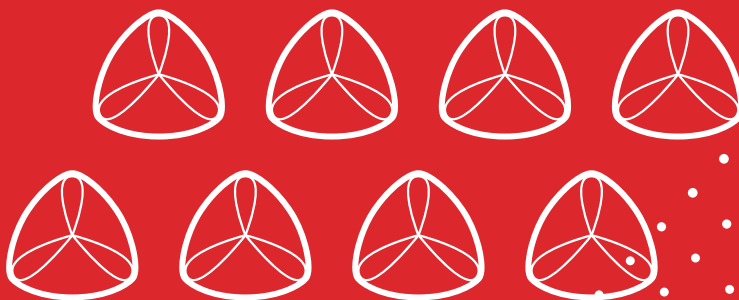

Appendix B - Robot Skills

Overview

This Appendix describes the Robot Skills Challenge rules for VEX Robotics Competition Over Under. All rules from "The Game" section of the manual apply to the Robot Skills Challenge, unless otherwise specified in this Appendix.

Robot Skills Challenge Description

In this challenge, *Teams* will compete in sixty-second (1:00) long *Matches* in an effort to score as many points as possible. These *Matches* consist of *Driving Skills Matches*, which are entirely driver controlled, and *Autonomous Coding Skills Matches*, which are autonomous with limited human interaction. *Teams* will be ranked based on their combined score in the two types of *Matches*.

The Robot Skills Challenge playing field is set up almost exactly the same as a Head-to-Head VEX Robotics Competition Over Under *Match*, with the following modifications:

- In *Autonomous Coding Skills Matches*, the VEX GPS code strip must be installed on the field
- The two (2) Blue *Alliance Triball Preloads* will not be used
- All of the forty-four (44) Match Load *Triballs* will be located in the red *Alliance Station*
- The pre-match placement of the twelve (12) *Triballs* on the field will be in non-scored positions as shown below

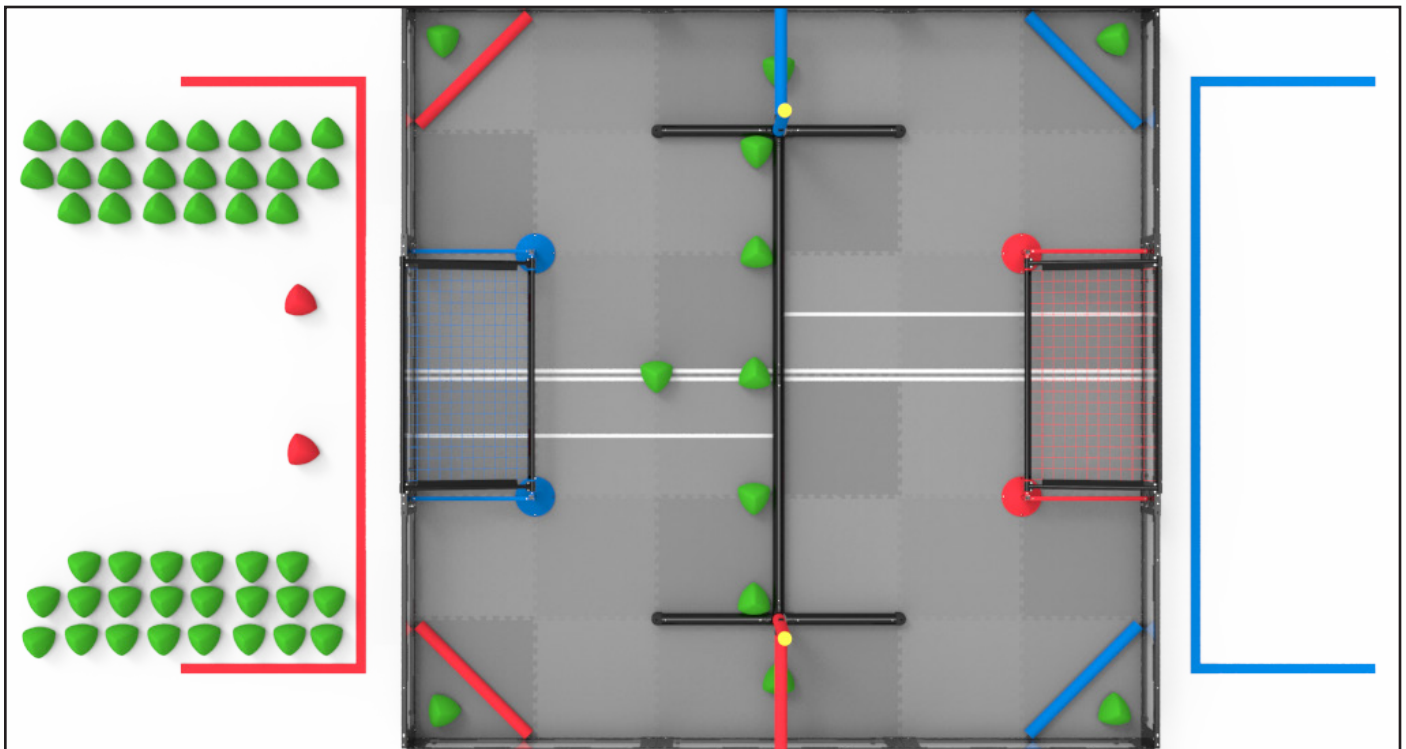

Robot Skills Challenge at a Standard Qualifying Tournament

- The Robot Skills Challenge is an optional event for all *Teams*. *Teams* who do not compete will not be penalized in the main tournament. However, participation in the Robot Skills Challenge may impact eligibility for judged awards at the event.
- *Teams* may play *Robot Skills Matches* on a “first come, first served” basis, or by a pre-scheduled method determined by the *Event Partner*.
- *Teams* will be given the opportunity to play exactly three (3) *Autonomous Coding Skills Matches* and three (3) *Driving Skills Matches*. *Teams* should be aware of when the Robot Skills fields are open so that they do not miss their opportunity. For example, if a *Team* waits until five minutes before the Robot Skills fields close, then they have not used the opportunity given to them and will not be able to compete in all six matches.
- Further details regarding Skills-Only Event logistics can be found in the REC Foundation Qualification Criteria document.

Robot Skills Challenge Definitions

All definitions from “The Game” section of the manual apply to the Robot Skills Challenge, unless otherwise specified.

Driving Skills Match – A *Driving Skills Match* consists of a sixty-second (1:00) *Driver Controlled Period*. There is no *Autonomous Period*. *Teams* can elect to end their run early if they wish to record a *Skills Stop Time*.

Autonomous Coding Skills Match – An *Autonomous Coding Skills Match* consists of a sixty-second (1:00) *Autonomous Period*. There is no *Driver Controlled Period*. *Teams* can elect to end their run early if they wish to record a *Skills Stop Time*.

Robot Skills Match – A *Driving Skills Match* or *Autonomous Coding Skills Match*.

Skills Stop Time – The time remaining in a *Robot Skills Match* when a *Team* ends the *Match* early.

- If a *Team* does not end the *Match* early, they receive a default *Skills Stop Time* of 0.
- The moment when the *Match* ends early is defined as the moment when the *Robot* is “disabled” by the field control system. See the “*Skills Stop Time*” section for more details.
- If a V5 Robot Brain or Tournament Manager display is being used for field control, then the *Skills Stop Time* is the time shown on the display when the *Match* is ended early (i.e. in 1-second increments).
- If a VEXnet Competition Switch is being used for field control, in conjunction with a manual timer that counts down to 0 with greater accuracy than 1-second increments, then the time shown on the timer should be rounded up to the nearest second. For example, if the *Robot* is disabled and the timer shows 25.2 seconds, then the *Skills Stop Time* should be recorded as 26.

Robot Skills Challenge Rules

<RSC1> All rules from “The Game” section of the manual apply to the Robot Skills Challenge, unless otherwise specified.

<RSC2> *Robots* may start the *Robot Skills Match* in any legal starting location for either *Alliance*.

- a. All *Drive Team Members* must be in the red *Alliance Station* for the duration of the *Match*.
- b. *Robots* must meet all of the criteria listed in rule <SG1>.
- c. *Teams* may use the two (2) red *Alliance Preloads* as follows:
 - i. One *Preload* must be placed per <SG4>.
 - ii. The second red *Alliance Triball* may be placed in any non-scored position in the Blue *Offensive Zone* and not touching the *Robot*, or may be used as a *Match Load* per <SG6> and <RSC3>.
- d. The two (2) blue *Alliance Triballs* are not used in *Robot Skills Matches*.

<RSC3> *Teams* may utilize the forty-four (44) *Match Load Triballs* within the guidelines set forth by <SG5>.

- a. *Match Load Triballs* begin the match in the red *Alliance Station*.
- b. *Match Load Triballs* must be introduced from the red *Alliance Station* per <SG6>.
- c. *Match Load Triballs* may be introduced during *Autonomous Coding Skills Matches* (i.e. the “Note” in rule <SG6> does not apply). Using sensors to detect legally-entered *Match Load Triballs* is not considered a violation of rule <G11>.

<RSC4> In *Robot Skills Matches*, *Teams* play as if they are on the red *Alliance*.

- a. *Robots* may freely move about the field after the start of the *Match*.
- b. *Robots* may utilize either *Elevation Bar*.
- c. Non-alliance specific *Triballs* may be scored in the red *Offensive Zone* and the red *Goal* per <SC3> and <SC4>.
- d. Red *Alliance Triballs* may be scored in the red *Offensive Zone*, the red *Goal*, or the blue *Goal* per <SC5>. Red *Alliance Triballs* cannot be *Scored* in the blue *Offensive Zone*.

<RSC5> Elevation points are awarded based on the *Elevation Tier* achieved by the *Robot* at the end of the *Match*. A *Robot's Elevation Tier* is measured by placing the *Height Guide* vertically next to an *Elevated Robot* and determining which letter-labeled segment of the *Height Guide* the lowest point of the *Robot* falls within. For *Robot Skills Matches*, tiers are assigned based on the following:

- Top Tier: H or higher (20 Points)
- 2nd Tier: E-G (15 Points)
- 3rd Tier: B-D (10 Points)
- 4th Tier: A (5 Points)

<RSC6> There is no requirement that Skills Challenge fields have the same consistent modifications as the Head-to-Head fields. For example, there is no requirement that all Skills Challenge fields are elevated to the same height as Head-to-Head fields. However, all Skills Challenge fields at a single event must use the same type of field control and field perimeter, as described in rules <T23> and <T24>.

It is strongly recommended/preferred that all Skills Challenge fields are consistent with each other, but this may not be the case in extreme circumstances.

In order to use non-conforming Head-to-Head fields for Skills Challenge runs (e.g. during lunch), the following steps should be taken:

- *Teams* must be informed that the Head-to-Head fields may have some differences from the Skills Challenge Fields (e.g., they might not have GPS strips).
- *Teams* must be given an opportunity to select which type of field they want to use, i.e. they cannot be required to use the Head-to-Head field for any Skills Challenge run.

<RSC7> *Triballs* which come to rest on top of the red *Goal* may not be retrieved by a *Drive Team Member* or Referee during the *Match*. *Triballs* which come to rest on top of the blue *Goal* may be retrieved by a *Drive Team Member* per <SG3>.

Robot Skills Challenge Scoring

Points are awarded according to the same scoring rules as Head-to-Head Matches, unless otherwise noted above. A *Team's* score at the end of a *Robot Skills Match* is calculated by combining the scores that would have been awarded to the red *Alliance*.

Skills Stop Time

If a *Team* wishes to end their *Robot Skills Match* early, they may elect to record a *Skills Stop Time*. This is used as a tiebreaker for Robot Skills Challenge rankings. A *Skills Stop Time* does not affect a *Team's* score for a given *Robot Skills Match*.

- *Teams* who intend to attempt a *Skills Stop Time* must "opt-in" by verbally confirming with the *Scorekeeper Referee* prior to the *Robot Skills Match*. If no notification is given prior to the start of the *Match*, then the *Team* forfeits their option to record a *Skills Stop Time* for that *Match*.
 - This conversation should include informing the *Scorekeeper Referee* which *Drive Team Member* will signal the stop. The *Match* may only be ended early by a *Drive Team Member* for that *Match*.
 - If a *Team* runs multiple *Robot Skills Matches* in a row, they must reconfirm their *Skills Stop Time* choice with the *Scorekeeper Referee* prior to each *Match*.
 - Any questions regarding a *Skills Stop Time* should be reviewed and settled immediately following the *Match*. <T1> and <T3> apply to *Robot Skills Matches*.

- If the event is utilizing a V5 Robot Brain or the TM Mobile app for Robot Skills Challenge field control, a *Drive Team Member* may elect to start and stop their own *Robot Skills Matches*.
 - This V5 Robot Brain or other device running the TM Mobile app will be used to start the *Robot Skills Matches* (i.e., "enable" the *Robot*), end the *Robot Skills Match* (i.e., "disable" the *Robot*), and display the official *Skills Stop Time* to be recorded.
 - This V5 Robot Brain must be running the official field control user program.
 - For more information regarding the use of a V5 Robot Brain for Robot Skills Challenge field control, and to download the official field control user program, [visit this VEX Knowledge Base article](#).
 - For more information regarding the use of TM Mobile for field control, [see the Tournament Manager documentation](#).

- At events which do not have a V5 Robot Brain or the TM Mobile App available for Robot Skills Challenge field control, *Drive Team Members* and field staff must agree prior to the *Match* on the signal that will be used to end the *Match* early.
 - As noted in the definition of *Skills Stop Time*, the moment when the *Match* ends early is defined as the moment when the *Robot* is "disabled" by the field control system.
 - The agreed-upon signal must be both verbal and visual, such as *Drive Team Members* crossing their arms in an "X" or placing their V5 Controller(s) on the ground.
 - The signal must be given by a *Drive Team Member* who is standing in the *Alliance Station*.
 - It is recommended that *Drive Team Members* also provide verbal notice that they are approaching their *Skills Stop Time*, such as by counting out "3-2-1-stop."

- It is at the *Event Partner's* discretion which method will be used to record *Skills Stop Times* at a given event. The chosen method must be communicated prior to the event (such as during a Drivers' meeting), and made equally available to all *Teams*.
 - If an event intends to use a manual timekeeping method, a *Team* may not bring their own V5 Robot Brain just for use during their own *Robot Skills Match*.
 - If an event intends to utilize a V5 Robot Brain, all *Teams* must use the same V5 Robot Brain for all *Robot Skills Matches* on a given field.
 - If an event is using multiple fields for *Robot Skills Matches*, the same method must be used at all fields, as described in rule <RSC6>. Multiple V5 Robot Brains may be used as needed (e.g., a "Field 1 Brain" and a "Field 2 Brain").
 - The default "Drive" program accessed from a V5 Controller is intended for practice only, and may not be used for an official *Robot Skills Match*.

Robot Skills Challenge Ranking at Events

For each *Robot Skills Match*, *Teams* are awarded a score as described in the Robot Skills Challenge Scoring section, and an optional *Skills Stop Time* as described in the *Skills Stop Time* section. *Teams* will be ranked based on the following tiebreakers:

1. Sum of highest *Autonomous Coding Skills Match* score and highest *Driving Skills Match* score.
2. Highest *Autonomous Coding Skills Match* score.
3. Second-highest *Autonomous Coding Skills Match* score.
4. Second-highest *Driving Skills Match* score.
5. Highest sum of *Skills Stop Times* from a *Team's* highest *Autonomous Coding Skills Match* and highest *Driving Skills Match* (i.e., the *Matches* in point 1).
6. Highest *Skills Stop Time* from a *Team's* highest *Autonomous Coding Skills Match* (i.e., the *Match* in point 2).
7. Third-highest *Autonomous Coding Skills Match* score.
8. Third-highest *Driving Skills Match* score.
9. If a tie cannot be broken after all above criteria, then the following ordered criteria will be used to determine which *Team* had the "best" *Autonomous Coding Skills Match*:
 - a. Number of *Triballs* scored in the Red Goal.
 - b. Number of *Triballs* scored in the Red Offensive Zone.
 - c. *Elevation Tier* points score

- If the tie still isn't broken, the same process in Step 9 will be applied to each *Team's* best *Driving Skills Match*.
- If the tie still isn't broken, events may choose to allow *Teams* to have one more deciding *Driving Skills Match*, to be ranked according to the standard criteria above, or declare both *Teams* the Robot Skills Challenge Winner.

Robot Skills Challenge Ranking Globally

Teams will be ranked globally based on their Robot Skills scores from Tournaments and Leagues that upload results to robotevents.com, according to the following tiebreakers:

1. Highest Robot Skills score (combined *Autonomous Coding Skills Match* and *Driving Skills Match* Score from a single event).
2. Highest *Autonomous Coding Skills Match* score (from any event).
3. Highest sum of *Skills Stop Times* from the *Robot Skills Matches* used for point 1.
4. Highest *Skills Stop Time* from the *Autonomous Coding Skills Match* used for point 2.
5. Highest *Driving Skills Match* score (from any event).
6. Highest *Skills Stop Time* from the *Driving Skills Match* score used for point 5.
7. Earliest posting of the Highest *Autonomous Coding Skills Match* score.
 - a. The first *Team* to post a score ranks ahead of other *Teams* that post the same score at a later time, all else being equal.
8. Earliest posting of the Highest *Driving Skills Match* score.
 - a. The first *Team* to post a score ranks ahead of other *Teams* that post the same score at a later time, all else being equal.

League Events

At league events in which *Teams* may submit Robot Skills Challenge scores across multiple days / sessions, the Robot Skills scores (combined highest *Autonomous Coding Skills Match* and *Driving Skills Match* scores) used for rankings will be calculated from *Matches* within the same session.

For example, consider the following scores for a hypothetical *Team* across two league event sessions:

	<i>Autonomous Coding Skills Match</i>	<i>Driving Skills Match</i>	Robot Skills Score
Session 1	100	100	200
Session 2	150	40	190

This *Team* would have a Robot Skills score of 200 for this event, and their scores from Session 1 would be used for the Event and Global tiebreakers listed in the above two sections.